

11/3/2016

CSS,PMS,PPSC,FPSC

BASIC COMPUTER BY MUNEEER HAYAT



Submitted By | Muneer Hayat 0300-5580,646

## *Chapter 2*

# **COMPUTER HARDWARE**

---

- 2.1 Components Of A Computer System
  - 2.1.1 Basic Components Of Computer
  - 2.1.2 Computer System
  - 2.1.3 Parts Of Computer System
    - 2.1.3.1 Hardware Components
    - 2.1.3.2 Software Components
- 2.2 Basic Architecture Of Computer System
  - 2.2.1 Basic Operations By Basic Units
    - 2.2.1.1 Input Unit
    - 2.2.1.2 Central Processing Unit (CPU)
    - 2.2.1.3 Output Unit
- 2.3 Types Of Computer Hardware
  - 2.3.1 Motherboard
  - 2.3.2 Input-Output Devices
    - 2.3.2.1 Input Devices
    - 2.3.2.2 Output Devices
- 2.4 Differentiate Between Impact And Non-Impact Printers
- 2.5 Differentiate Between Dot Matrix Printers And LASER Printers
- 2.6 Input-Output Devices (I/O Devices)
  - 2.6.1 Functions Performed By An Input-Output Device:
  - 2.6.2 Examples Of Input-Output Devices:
- 2.7 Microprocessor or Central Processing Unit (CPU)
  - 2.7.1 Processor Speed Or Clock Speed
  - 2.7.2 Functions Of Central Processing Unit (CPU)
  - 2.7.3 Major Parts Of Processing Unit (CPU)
  - 2.7.4 Functions Of Different Parts Of CPU
    - 2.7.4.1 Arithmetic Logic Unit (ALU)
    - 2.7.4.2 Memory Unit (MU)
    - 2.7.4.3 Control Unit (CU)
- 2.8 Memory
  - 2.8.1 Units To Measure Memory
  - 2.8.2 Types Of Memory
    - 2.8.2.1 Primary Memory Or Primary Storage Devices
    - 2.8.2.2 Secondary Memory Or Secondary Storage Devices
  - 2.8.3 Special Memories
    - 2.8.3.1 Types Of Special Memory
- 2.9 Difference Between Primary Memory And Secondary Memory
- 2.10 Difference Between RAM And ROM
- 2.11 Difference Between SRAM And DRAM

### Exercise

Long Questions

Short Questions With Answers

2.1

# COMPONENTS OF A COMPUTER SYSTEM

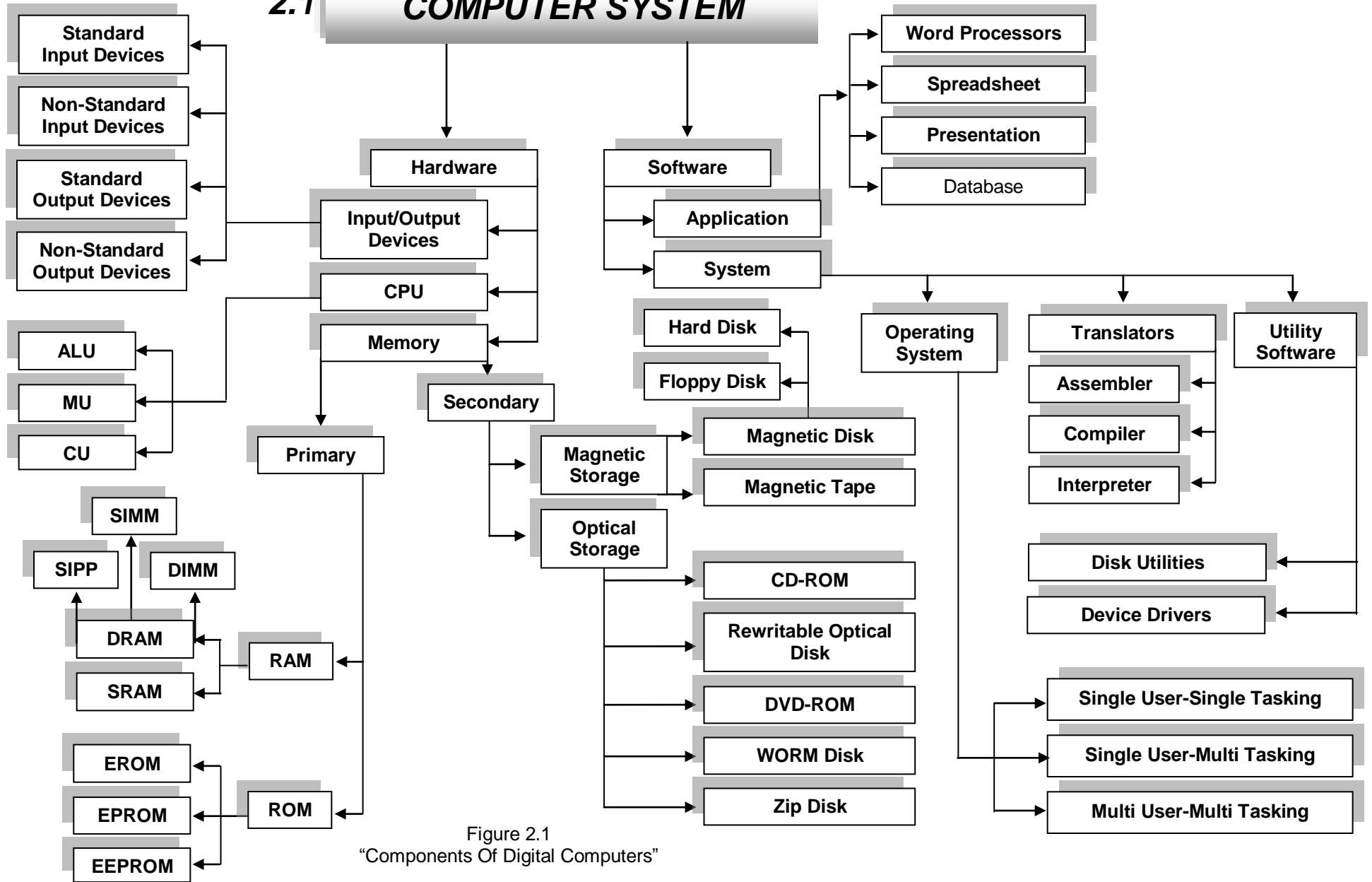

Figure 2.1  
"Components Of Digital Computers"

## 2.1.1 BASIC COMPONENTS OF COMPUTER SYSTEM

Here is the representation of basic components of any computer system:

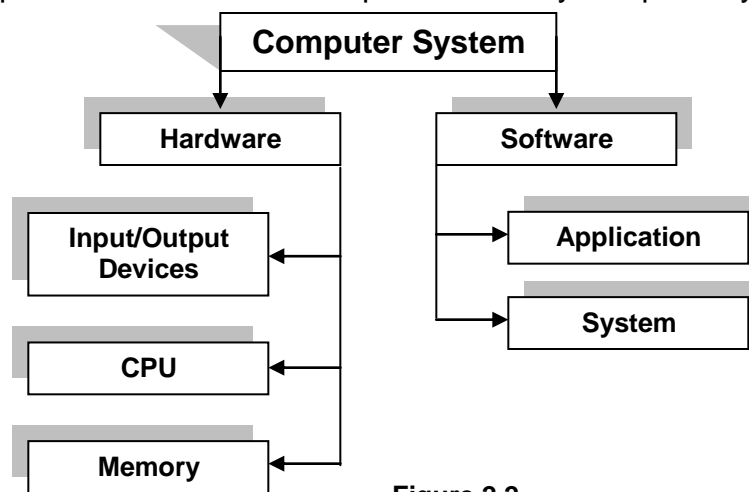

Figure 2.2  
“Basic Components of a Computer System”

## 2.1.2 COMPUTER SYSTEM

A system is a group of related components that make up a body to perform a specific function. Therefore, computer system is defined as:

“The computer along with various units and software that perform different activities in data processing is collectively known as computer system”

## 2.1.3 PARTS OF COMPUTER SYSTEM

Any computer system can be divided into two basic components:

1. Hardware Components
2. Software Components

### 2.1.3.1 HARDWARE COMPONENTS

Computer Hardware can be defined as:

“Electronic and mechanical devices that make up the computer are called the hardware”

Computer hardware refers to all the physical, tangible components related to computers. We can say that the “computer hardware” is the structural study of computers. All the physical items like Printers, Monitors, Keyboard, Mouse, Disks, Chips and Circuits etc. are included in the computer hardware.

“The physical and permanent components of a computer are called hardware”

So, hardware components are the physical and tangible parts of computer system without which computer system can not be complete.

## **TYPES OF HARDWARE**

Hardware can be divided into three basic types:

1. Input/output devices
2. Central Processing Unit (CPU)
3. Memory

### **2.1.3.2 SOFTWARE COMPONENTS**

“A set of electronic instructions consisting of complex codes, or programs, that makes up the computer are called the software”

Computer software refers to the instructions to operate the hardware. We can say that “computer software” is the functional study of computers. Computer software includes applications and programs like Word processor, Spreadsheets, Databases, Graphical programs, Multimedia programs etc. So, softwares are the non-physical and in-tangible parts of computer system without which computer system can not be complete.

## **TYPES OF SOFTWARE**

Software can be divided into two basic types:

1. System Software
2. Application Software

## **2.2 BASIC ARCHITECTURE OF COMPUTER SYSTEM**

The basic or internal architectural design of computer differs from one system model to another. However the basic organization remains same for all computer systems. As shown in the following figure of “data processing cycle”, the user inputs the data through input unit; the data goes for processing, meanwhile or after processing results stored in memory temporarily/permanent and then the output of results (information) goes to output unit.

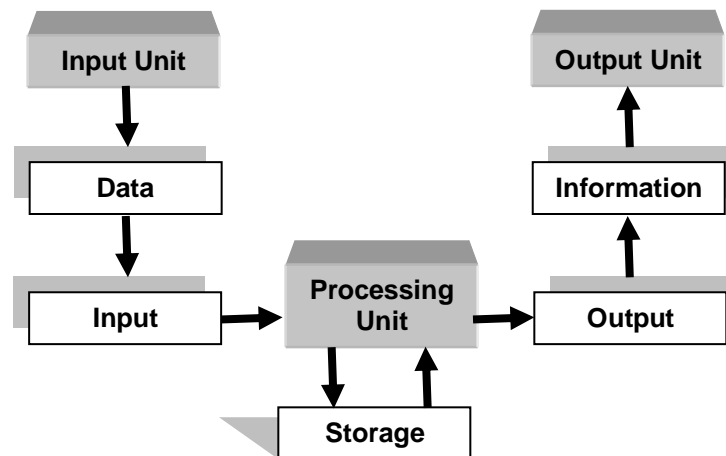

Figure 2.3  
“Data Processing Cycle”

### **2.2.1 BASIC OPERATIONS BY BASIC UNITS**

These three basic units correspond to the five basic operations performed by the computer system.

1. Input Unit

2. Output Unit
3. Processing Unit
  - i. Memory Unit
  - ii. Arithmetic Logic Unit
  - iii. Control Unit

Following is a block diagram of the organization of basic computer units; in this figure the solid lines are used to indicate the flow of instruction and data, and the dotted lines represent the control exercised by the control unit. It displays the five major building blocks, or functional units of a digital computer system.

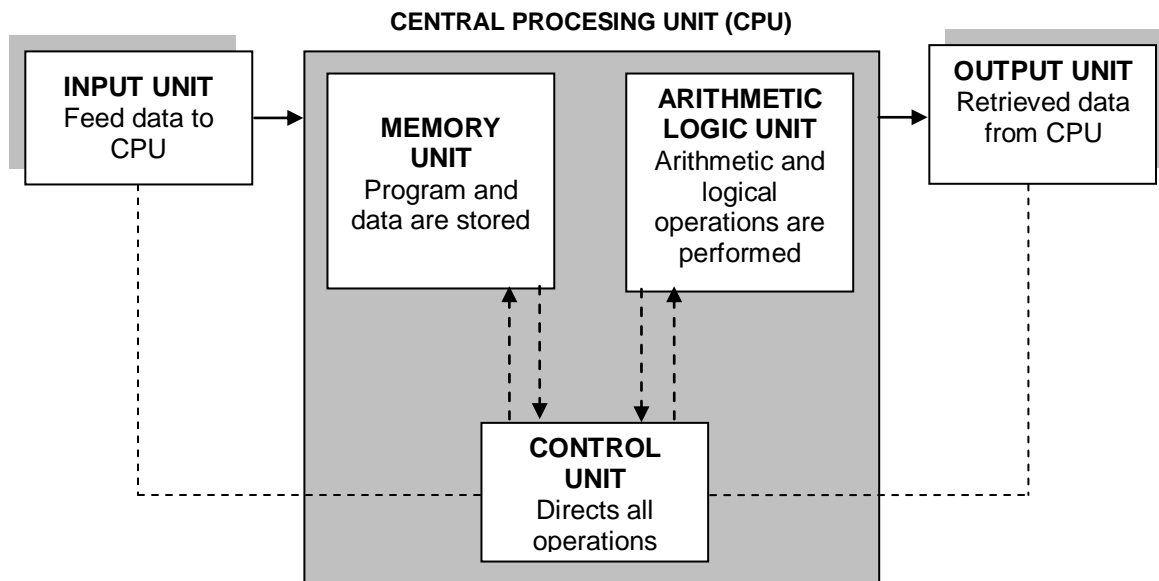

Figure 2.4  
"Representation of Computer Structure"

### 2.2.1.1 INPUT UNIT

Input unit can be defines as:

"Unit which is used to get data from  
the user to computer is called the input unit"

The input unit receives the input of data which is in need of processing. For this purpose different input devices (i.e. keyboard, mouse etc) can be used. These devices are helpful to make connection between the outer environment and the inner environment of the computer. The data provided by the input devices to the computer is transformed into the binary codes which are acceptable by the computer memory.

Following are the functions performed by the input unit:

1. It accepts (or reads) the list of instructions and data from the outside world of computer.
2. It converts these instructions and data in computer acceptable form.
3. It supplies the converted instructions and data to the computer system for further processing.

### 2.2.1.2 CENTRAL PROCESSING UNIT (CPU)

Central processing unit can be defined as:

“The computer’s brain which organizes and carries out instructions from either the user or the software”

CPU resides on a circuit board called the **motherboard** and can be described as the "brains" of the computer. The control unit (CU), memory unit (MU) and the arithmetic logic unit (ALU) of a computer system are jointly known as the “central processing unit (CPU)”. The CPU is the brain of any computer system. In a human body, all decisions are taken by the brain and the other parts of the body function as directed by the brain. Similarly, in a computer system, all calculations and comparisons are made by or inside the CPU and the CPU is also responsible for activating and controlling the operations of other units of computer system.

### ***FUNCTIONS OF CENTRAL PROCESSING UNIT (CPU)***

CPU performs the following main functions:

1. Fetch (read) data and programme instructions
2. Decode them
3. Execute them
4. Control the flow of program and data in and out of RAM
5. Place results of processing in memory

### ***PARTS OF CENTRAL PROCESSING UNIT (CPU)***

1. Arithmetic and Logic Unit (ALU)
2. Memory Unit (MU)
3. Control Unit (CU)

### ***MEMORY UNIT (MU)***

The memory unit of CPU is the place where the computer program and data are stored during processing. It is a random access storage device consisting of thousands upon thousands of **storage locations**, each of which can be directly reached by the control unit. Each storage location is distinguished by a unique number called its **Address**. During a processing procedure, different data may be stored in any given storage location, but the address of the storage location is fixed. For example: the memory unit is often compared to a post office. At various times different letters are placed in a postal box, but the box number is always the same.

Following are the basic functions performed by the memory unit:

1. Having all the data to be processed and the instructions required for processing (received from input devices).
2. Having intermediate results of processing.
3. Having final results of processing before these results are released to an output device.

### ***ARITHMETIC LOGIC UNIT (ALU)***

The arithmetic logic unit (ALU) of a computer system is the place where the actual execution of the instructions takes place during the processing operation. All calculations are performed and all comparisons (decisions) are made in ALU. Data stored in primary storage before processing, transferred as and when needed to ALU where processing take place. After processing data transferred to primary storage, so data may move from primary storage to ALU and back again to storage many times before processing is over. After the completion of processing, the final results which are stored in the storage unit are released to an output unit.

Following are the basic functions performed by the arithmetic and logic unit:

1. It performs arithmetic processing like addition, subtraction, multiplication and division.
2. It performs logical processing like less than, greater than, equal to etc.

### **CONTROL UNIT (CU)**

It is the control unit who tell the input unit that it is time for it to feed data into the memory unit. It also handles ALU to tell what should be done with the data when it receives it. Control unit is also responsible to send only the final results to output device not the intermediate results. It is the responsibility of control unit to maintain order and direct the operation of the entire system. Although, it does not perform any actual processing on the data, the control unit acts as a central nervous system for the other components of the computer. It manages and coordinates the entire computer system. It obtains instructions from the program stored in main memory (RAM), translate the instructions, and issues signals that cause other units of the system to execute them.

Following are the basic functions performed by the control unit:

1. It controls all the units or parts of computer system directly or indirectly.
2. Directly control to ALU and MU.
3. Indirectly control to input and output units.

### **2.2.1.3 OUTPUT UNIT**

Output unit can be defined as:

“Unit which is used to get data from  
the computer to user is called the output unit”

This unit supplies information and results of computation to the outside world. Thus it links the computer with the external environment. As the results are in the binary form, so the conversion of these binary codes to user understandable form is the responsibility of output devices (i.e. monitor, printer etc.)

Following are the functions performed by the output unit:

1. It accepts the results produced by the computer which are in coded form and hence cannot be easily understood by us.
2. It converts these coded results to human acceptable(readable) form,
3. It supplies the converted results to the outside world.

## **2.3 TYPES OF COMPUTER HARDWARE**

As we already defined and briefly explained the hardware components of any computer system, now here we will discuss in detail about different types of computer hardware as shown in the following figure.



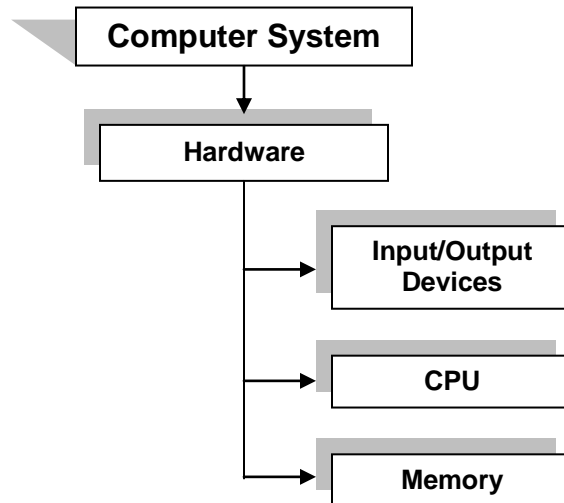

Figure 2.5  
 “Basic Types of Computer Hardware”

### 2.3.1 MOTHERBOARD

Motherboard can be defines as:

“All the physical components of computer  
 reside on a circuit board called the motherboard (or mainboard)”

It is the primary circuit board within a personal computer. Components connect directly or indirectly to the motherboard. Motherboards usually contain one or more CPUs, supporting circuitry -- usually integrated circuits (ICs) providing the interface between the CPU memory and input/output peripheral circuits, main memory, and facilities for initial setup of the computer immediately after being powered on. A motherboard also contains one or more peripheral buses and physical connectors for expansion purposes. Sometimes a secondary **daughter board** is connected with the motherboard to provide further expandability or to satisfy space constraints.

### 2.3.2 INPUT-OUTPUT DEVICES

The input-output devices provide the means of communication between the computer and the outer world. They are also known as *Peripheral Devices* because they surround the PC. Input devices are used to enter data into the primary storage and output devices accept results from the primary storage to supply them to the users or to store them on a secondary storage device for future processing. There are some devices which are used for both the input and the output functions.

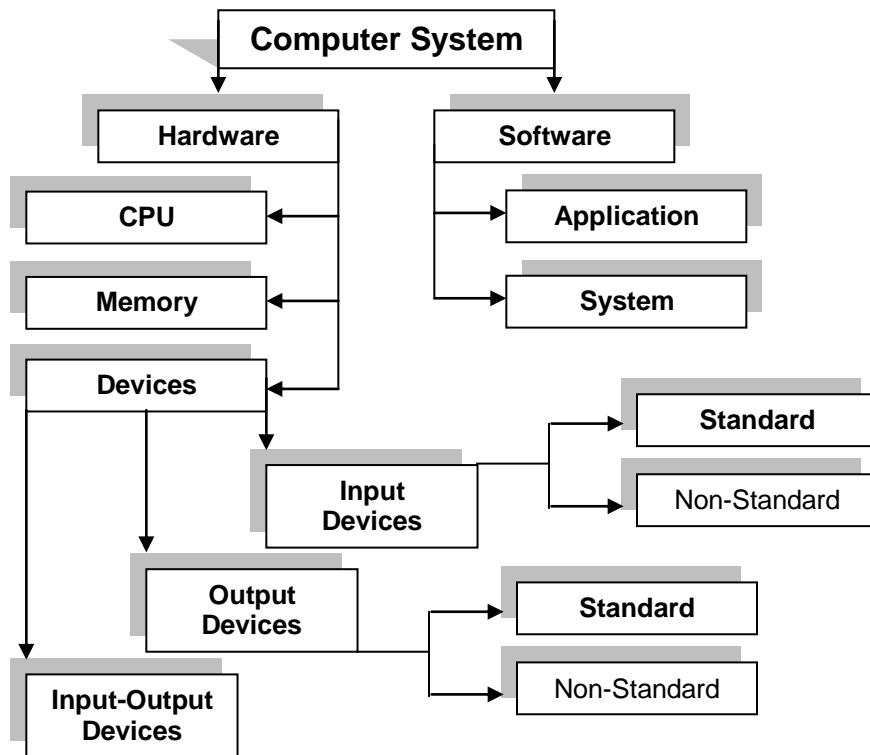

Figure 2.6  
"Types of Devices"

### 2.3.2.1 INPUT DEVICES

We will discuss about input devices, but first to know that what is input and what is device.

#### **INPUT**

The word "input" can be defined as:

"It is a process to enter something"

#### **DEVICE**

The word "device" can be defined as:

"Device is purely based on electronics circuits"

#### **INPUT DEVICE**

Input devices can be defined as:

"A device which is used to accept data from the user, translate it into computer understandable form and sends to internal parts for further processing"

The input unit receives the input of data which is in need of processing. For this purpose different input devices (i.e. keyboard, mouse etc) can be used. These devices are helpful to make connection between the outer environment and the inner environment of the computer. The data provided by the input devices to the computer is transformed into the binary codes which are acceptable by the computer memory.

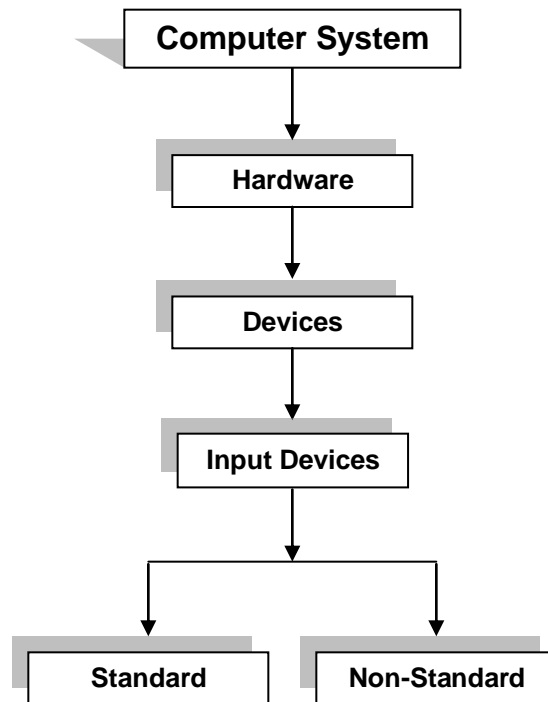

Figure 2.7  
“Hierarchy For Input Devices”

### ***FUNCTIONS PERFORMED BY AN INPUT DEVICE***

Following are the functions performed by the input unit:

1. It accepts (or reads) the list of instructions and data from the outside world.
2. It converts these instructions and data in computer acceptable form.
3. It supplies the converted instructions and data to the computer system for further processing.

### ***TYPES OF INPUT DEVICES***

Mainly we can divide the input devices into two categories:

1. Standard input devices
2. Nonstandard input devices

### ***STANDARD INPUT DEVICES***

Following two devices are considered as the standard input devices because these are the most probably found input devices with most of the computers:

1. Keyboard
2. Mouse

### ***NON-STANDARD INPUT DEVICES***

Input devices other than “Standard Input devices” are considered as the non-standard input devices. Following are the examples of some non-standard input devices:

1. Scanner
2. Joystick
3. Light Pen
4. Digitizing Tablet
5. Hand Tracker
6. Track Ball

7. Track Points
8. Track Pads
9. Speech Recognition System i.e. Microphone
10. Vision Input System i.e. Digital Camera etc.

### **KEYBOARD**

Keyboard can be defined as:

“A Keyboard is the standard data input and operator control device for a computer”

Most computers would be useless without keyboard. Keyboard is a main device through which computer receives users input. It is good for entering alpha numeric data. The computer encodes the keyboard characters using the American Standard Code for Information Interchange (ASCII). Each key has a unique 7-bit ASCII code associated with it, with which we can communicate with the computer. The common arrangements of alphanumeric keys on keyboard is called QWERTY layout (first six keys on the top row of letters). Among IBM-compatible computers, the most common layout is the IBM Enhanced Keyboard. It has 101 keys arranged in six groups.

### **TYPES OF KEYBOARD**

There are two types of keyboards:

1. General Function Keyboard
2. Special Function Keyboards

### **GENERAL FUNCTION KEYBOARDS**

These are traditional input device also known as “alphanumeric keyboards”.

### **SPECIAL FUNCTION KEYBOARDS**

These are the keyboards designed to perform input of special type of data in a special way. Sometimes these are designed for special persons.

### **IBM-COMPATIBLE KEYBOARD LAYOUT**

Among IBM-compatible computers, the most common layout is the “IBM Enhanced Keyboard”. It has 101 keys arranged in following six groups:

1. Alphanumeric keys
2. Modifier keys
3. Numeric keypad
4. Function keys
5. Cursor-movement keys
6. Special-purpose keys

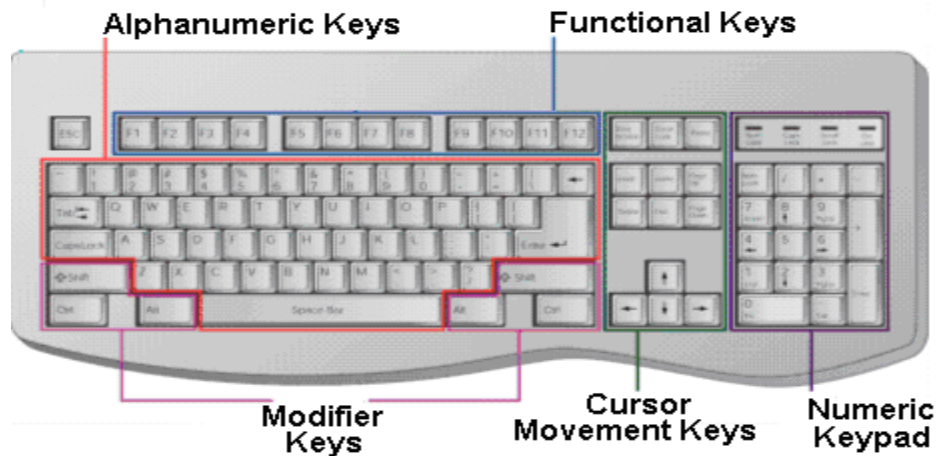

Figure 2.8  
"IBM-Compatible Keyboard Layout"

### ***THE ALPHANUMERIC KEYS***

Along with keys that produces letters (A to Z and a to z) and numbers (0 to 9), the alphanumeric key group includes a few additional keys, with special functions. Following are the names and details of these keys:

#### **Tab:**

1. It moves cursor to predefined tab stops in many application programs (such as in word processors).
2. In dialog boxes, we can press Tab to move from one option or field to another.

#### **Caps Lock:**

1. It locks the alphabet keys to so they produce only capital letters. Caps Lock does not affect the numeric keys or the keys that produce punctuation or special characters.

#### **Backspace:**

1. It enables us to erase characters we just typed or to erase a character present at the left of cursor.

#### **Spacebar:**

1. it jumps for the space of single character.

#### **Enter:**

1. It is also known as Return Key. It lets us finalize data entry in many types of application programs.
2. We can use it to choose a command or option in many programs.

### ***THE MODIFIER KEYS***

These keys are used to modify the input of other keys. We press another key while holding down a modifier key. Following are the names and details of these keys:

#### **Shift:**

1. When we press a Shift key with the combination of any alphanumeric key, it forces the computer to output a capital letter or symbol.
2. We can use it with Cursor-Movement Keys to select text for editing.

#### **Ctrl:**

It is an abbreviation of "Control". Produces different results depending upon the program used. For example:

1. In many Windows-based programs, Ctrl-key combination provides shortcuts for menus commands i.e. Ctrl+S is for saving a file.

**Alt:**

It is an abbreviation of “Alternative”. Operate like Ctrl-key, except that it produces a different set of results. For example:

1. In many Windows-based programs, Alt-key combination enables us to navigate menus and dialog boxes without using mouse.

**THE NUMERIC KEYPAD**

It usually located on the right side of the keyboard. Looks like an adding machine, with its ten digits (0 to 9) and mathematical operators (+, -, \* and /). The Numeric keypad also has a Num Lock Key.

**Num Lock:**

1. When Num Lock is deactivated, the numeric keypad’s keys perform cursor movement control and other functions.
2. When Num Lock is activated, the numeric keypad’s keys perform their functions of using digits and mathematical operators.

**THE FUNCTION KEYS**

The keys are usually arranged in a row along the top of the keyboard, these are twelve in number from F1 to F12. Each Function key’s purpose depends on the program we are using. For example, F1 is the help key.

**THE CURSOR-MOVEMENT KEYS**

These help the users to move around the screen by changing the position of cursor. Most keyboards include the following standard cursor-movement keys:

**Arrow Keys:**

These are four in number and labeled by arrow pointing in a specific direction.

1. These keys move the cursor up or down a single line, or left or right one character space.
2. Their behavior can be modified by using Shift and/or Ctrl keys, depending on the program we are using e.g. to move a greater distance or to select text for editing.

**Home/End:**

Depending on the program we are using:

1. We maybe able to press Home to move the cursor to the beginning of the line and End to move the cursor at the end of the line.
2. Used with the combination of modifier keys, Home and End may move the cursor greater distances.

**Page Up/Page Down:**

They let us “flip” through a document, screen by screen like turning the pages of a book.

1. Press Page Up to jump to the previous screen. Press Page Down to jump to the next page.
2. Their function maybe affected by modifier keys, depending on the program we are using.

**SPECIAL-PURPOSE KEYS**

In addition to the five groups of keys described, IBM-compatible keyboards features six special-purpose keys, each of which performs a special function:

**Insert:**

1. It may be used to switch a program:

- a) From “insert Mode” i.e. where text is inserted into the document at the cursor.
  - b) To “Overtyping Mode” i.e. where new text is typed over existing text.
2. The function insert maybe affected by modifier keys, or depending on the program we are using.

**Delete:**

It is used to delete characters from document:

1. Used alone, Delete removes a single character at a time at the cursor’s location.
2. In combination with modifier keys and depending on the program we are using, Delete may be able to remove multiple characters of text.

**Note:** The Delete and Backspace keys function is opposite ways. Delete erases characters to the right of the cursor and Backspace erases characters to the left of the cursor.

Insert and Delete keys are also known as Editing Keys.

**Esc:**

Its function depends on the program or operating environment.

1. Generally it is used to “back up” one level in a multilevel environment.

**Print Screen:**

This key allows the user to capture whatever is shown on the screen as an image. The image can be printed, pasted into a document, or manipulated in various ways of the software.

**Scroll Lock:**

Its function depends on the program or operating environment.

1. Usually this key controls the functions of the cursor-movement keys.
2. In some programs (e.g. in MS-Excel), it causes the cursor to remain stationary on the screen, and the document’s contents move around it. When it is turned off, the cursor moves normally, (this does not function at all in some programs).

**Pause:**

In some programs, the Pause key can be used to stop a command in progress.

**Start:**

It is sometimes called “Windows logo key”, as it has the Windows logo on it.

1. It opens the Start menu in Windows 95, 98, 2000 and NT operating systems, which is same as clicking over Start button on taskbar.
2. This key can be programmed to perform other tasks.

**Shortcut:**

It is sometimes called “Application key”, as it can be programmed to open a specific application instantly.

1. It has the image of a menu.
2. It opens an on-screen shortcut menu in Windows-based application programs, which is same as right-clicking within a Windows application window.

**MOUSE**

It is an input device used to control the position of the cursor and moves it around the screen. It is a “point and draw” input device.

“A Mouse is a point and draw type of standard input device that rolls around on a flat surface and controls the pointer”

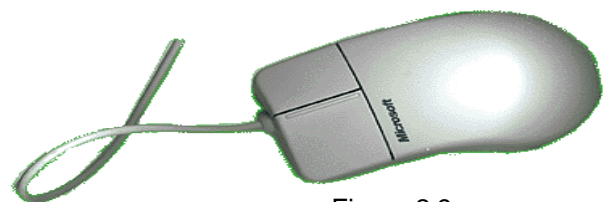

Figure 2.9  
“A Mouse”

The mouse is mainly used in the GUI (graphical user interface) environments. Mouse has a right and left buttons in common. Many recent mice have a scroll wheel as the middle button. There are new mice that don't have a ball at all. They use a laser to sense the motion of the mouse instead.

### **FUNCTIONS/OPERATIONS OF MOUSE**

Following are the functions of a mouse:

1. Pointing
2. Clicking
3. Double-clicking
4. Dragging
5. Dragging and Dropping
6. Right-clicking

#### **Pointing:**

When we move the cursor of the mouse to an icon and leave it over there it is called pointing.

#### **Clicking:**

While pointing to an icon if we press and release a button of the mouse there, it is called clicking.

#### **Double-clicking:**

If we click and release quickly for two times this is called double-clicking.

#### **Dragging:**

If we point to a graphic icon, press button over there and hold it down and move our hands across the screen, this function is called dragging.

#### **Dragging and Dropping:**

If we drag a graphical icon across the screen to our desired position and release the pressed button over there then this function will be called to dragging and dropping.

#### **Right-clicking:**

If we point to a graphic icon, press right mouse button, a menu related to the properties of that icon opens, this is called the right-clicking.

### **SCANNER**

Scanners allow information such as a photo or text to be input into a computer i.e. it is used to convert hardcopy into softcopy. Scanners are usually either A4 size (flatbed), as shown below or hand-held to scan a much smaller area.

Scanner uses the LASER technology, and these are equipped with the Optical Character Recognition (OCR) ability, which is the ability to read printed information into a computer system.

### **KINDS OF SCANNER**

Following is the list and then brief detail of each type of scanner:

1. Flat bed scanner
2. Hand held scanner
3. Sheet fed scanner
4. Slide scanner
5. Phot scanner
6. Drum scanner
7. Bar code scanner
8. Cross hair cursor machine



- 9. Magnetic ink character reader (MICR)
- 10. Optical mark reader (OMR)

**FLAT BED SCANNERS**

They have a flat bed against which the printed information or graphics are placed, which is then encoded and sent to the computer the information is displayed on the monitor.

**Example:** NADRA uses such type of scanners etc.



Figure 2.10  
"Flatbed Scanners"

**HAND HELD SCANNERS**

These are moved in the document to be scanned and they encoded data into digitized form. These can scan a book without breaking it.

**Example:** These are used to read data on price tags, shopping labels and inventory part numbers etc.

**SHEET FED SCANNERS**

These scanners use motor driven rollers to pull the documents or data sheets to be scanned through these devices.

**SLIDE SCANNERS**

These scanners use motor driven film holder that can pull a slide, film strip etc.

**Example:** These are mostly used in film industry etc.

**PHOT SCANNERS**

These are used to scan only the photos or film strips.

**Example:** These are mostly used in photo studios etc.

**DRUM SCANNERS**

In these scanners the media or data sheets to be scanned are attached to a rotating drum, which rotates at speed of several thousands of rounds per minute.

**BAR CODE SCANNERS**

A bar code is a pattern printed in lines of differing thickness. The system gives fast and error-free entry of information into the computer.

**Example:** These are used to read data on price tags, shipping labels and inventory part numbers etc.

**CROSS HAIR CURSER MACHINE**

This type of scanner is used to make cartoons, maps, designs and photo like the image of Quaid-i-Azam on currency notes etc.

**MAGNETIC INK CHARACTER RECOGNITION (MICR) SCANNER**

Cheques and drafts in banks are written in special ink that had magnetic elements included in it. These scanners are used in banks to recognize the amounts written in such inks.

**Examples:** This method is used to run bank cash points or to provide quick identification of people entering buildings.



Figure 2.11  
"A Bar Code"



Figure 2.12  
"An Infra-red Bar Code Reader"

**OPTICAL MARK READER (OMR)**

The Optical Mark Reader (OMR) can read information in the form of numbers or letters and put it into the computer.

The marks have to be precisely located as in multiple choice test papers.

**Example:** Normally used in university to speedy checking of papers etc.

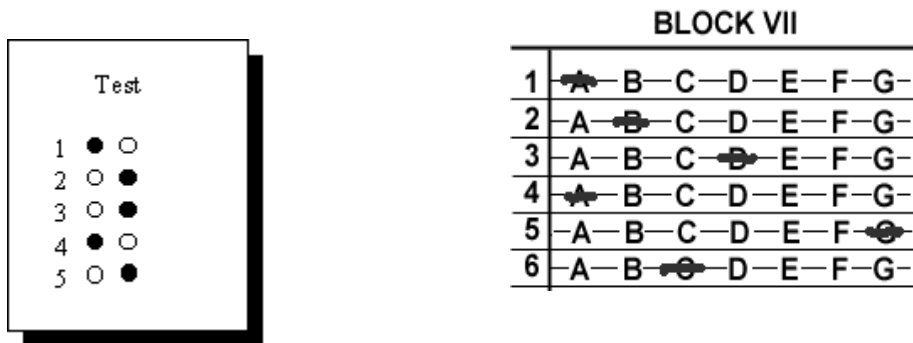

Figure 2.13 and 2.14  
"Sample Multiple Choice Answer Papers"

**JOYSTICK**

The joystick is just like a lever. Similar to an aircraft's control stick, it enables us to move within the screen's environment, and is widely used in the computer games industry.



Figure 2.15  
"A Joystick"

**LIGHT PEN**

A Light Pen is a pointing device shaped like a pen and is connected to a Video Display Unit (VDU). The tip of the light pen contains a light-sensitive element which, when placed against the screen, detects the light from the screen enabling the computer to identify the location of the pen on screen.



Figure 2.16  
"A Light Pen"

Light pens have the advantage of 'drawing' directly onto the screen, but this can become uncomfortable, and they are not as accurate as Digitizing tablets.

**DIGITIZING TABLET**

Consists of a pen and a pressure sensitive tablet. This enable the user to perform pen based computing. Such as drawing and entering handwritten data to the system.

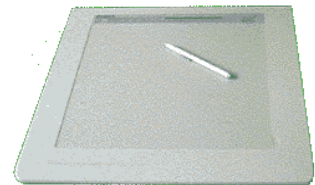

Figure 2.17  
"Digitizing Tablet"

A Digitising Tablet is a pointing device that facilitates the accurate

input of drawings and designs. A drawing can be placed directly on the tablet, and the user traces outlines or inputs coordinate positions with a hand-held stylus.

**HAND TRACKER**

A glove with sensors. While moving hand, sensor detects the motion and gets the input from that motion. As a result system gets input and respond accordingly.



Figure 2.18  
"Hand Tracker"

Such hand tracker are used in video games and for training purpose as well.



Figure 2.19  
"Track Ball"

### **TRACK BALL**

This is a ball inserted in an external box or fixed in the keyboard. The ball is rolled with the fingers to move the graphic cursor.

### **TRACK POINTS**

These work like a small joy stick and are operated with the finger of the hand. Used in the video games or very commonly used as a “remote control” of televisions, VCRs, security systems etc.



Figure 2.20 “A Track Point”

### **TRACK PADS**

Have no moving parts; simply we move finger about a touch sensitive pad to move the graphic cursor. It is normally used in laptops.



Figure 2.21  
“A Touch/Track Pad”

### **SPEECH RECOGNITION SYSTEM/ MICROPHONE (VOICE DATA ENTRY)**

This system accepts the spoken words as input data or commands. Human speech is very complex, involving emphasis and facial expressions, so complete voice recognition will not be developed for some time.

However, simple commands from one user can be used to control machines.

In this way a paralyzed person can operate a wheelchair or control heating and lighting. Sales personnel in the field, surgeons in the operation theatres and workers on airports etc. use such devices. Microphone is a good example of such devices.



Figure 2.22  
“Microphone”

### **VISION INPUT SYSTEM**

A computer does not see and interpret an image in the way as human beings do. Digital Stills Cameras capture an image which is stored in memory within the camera. When the memory is full it can be erased and further images captured.

The digital images can then be transfer from the camera to a computer where these can be displayed, manipulated or printed. Web-cam is another example of vision input system used for communication over the Internet.



Figure 2.23  
“Digital Cameras”

### **2.3.2.2 OUTPUT DEVICES**

We will discuss about input devices, but first to know that what is input and what is device.

### **OUTPUT**

The word “output” can be defined as:

“It is a process to get something”

### **OUTPUT DEVICES**

Output devices can be defined as:

“A device which is used to get processed data called information, translate it into user understandable form, and gives output”

These are the devices which are purely used to get information from the computer or these are the devices through which computer communicates with the outside world, the output may be in the form of display (i.e. monitor), voice (i.e. speaker) or in written (i.e. printer).

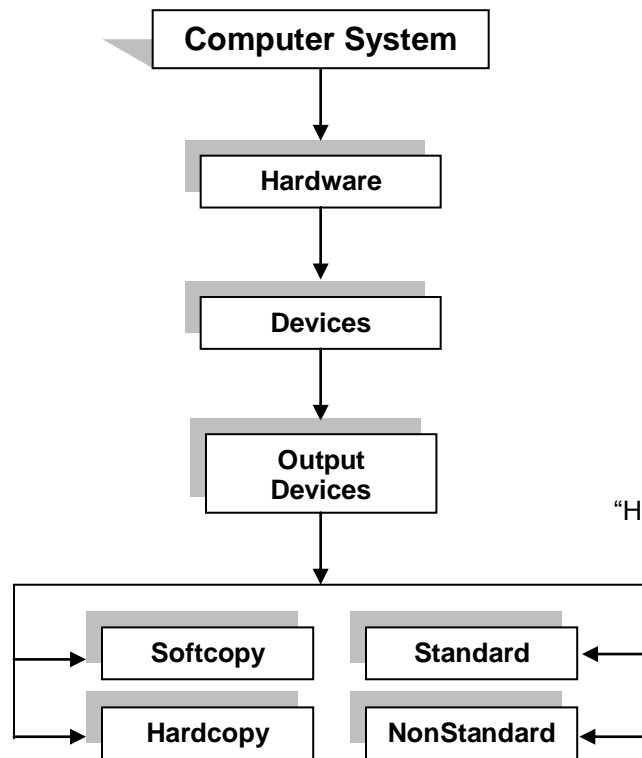

Figure 2.24  
“Hierarchy For Output Devices”

### ***FUNCTIONS PERFORMED BY AN OUTPUT DEVICE***

Following are the functions performed by the output unit:

1. It accepts the results produced by the computer which are in coded form and hence cannot be easily understood by us.
2. It converts these coded results to human acceptable (readable) form,
3. It supplies the converted results to the outside world.

### ***KINDS OF OUTPUT DEVICES***

Output devices can be classified into two ways:

1. Standard and Nonstandard output devices
2. Softcopy and Hardcopy output devices

### ***STANDARD OUTPUT DEVICES***

Following two devices are considered as the standard output devices because these are the most probably found output devices with most of the computers:

1. Monitor
2. Printer

### ***NON-STANDARD OUTPUT DEVICES***

Output devices other than “Standard Output devices” are considered as the non-standard output devices. Following are the examples of some non-standard output devices.

1. Plotter
2. Speaker
3. Computer Micro File (COM)
4. PC Projector or LCD Projection panels etc.

### **SOFTCOPY OUTPUT DEVICES**

These are the devices, which are used to produce a softcopy of the output. Softcopy can be seen or heard i.e. it is the copy of document inside the computer. When power is switched off this copy is vanished, so a softcopy of a document is of temporary nature.

Following is the list and brief detail of softcopy output devices;

1. Monitor
2. Speaker
3. PC Projector etc

### **MONITOR**

Monitors can be defined as:

“It is a softcopy, standard output device, used to graphical type output”

It is widely in use and also known as Display Unit, Screen, Display Screen, Video Display Terminal (VDT), Video Display Unit (VDU), Screens, Cathode Ray Tube (CRT), Liquid Crystal Display (LCD) etc. There is a cathode ray tube installed in monitors. Monitors vary in their quality of output called Resolution. The larger the number of pixels the finer is the resolution. The high resolution monitors give extremely clear images that look almost like a photograph. Their sizes vary from 3 inches to 30 inches but 14”, 15”, 17”, and 21” are the standard sizes.

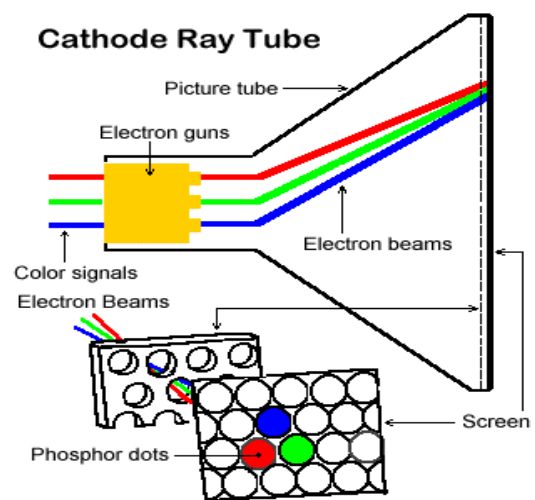

Figure 2.25  
“CRT Structure”

### **KINDS OF MONITORS**

Monitors can be classified according to:

1. Display
2. Resolution
3. Screen size
4. Volume

### **KINDS OF MONITORS - ACCORDING TO DISPLAY**

There are three kinds of monitors according to their display:

1. Monochrome
2. Grayscale
3. Color

### **MONOCHROME MONITOR**

These monitors display images in a single color, usually white, green, blue, red or amber (yellowish brown color). These monitors are becoming outdated.

### **GRAYSCALE MONITORS**

These monitors displays us the shades of gray on a white or off-white background. These monitors are also becoming outdated.

### **COLOR MONITORS**

Color monitor mix red, green and blue (RGB) to achieve a spectrum of colors. Four most popular monitors are:

1. **CGA** or Color Graphic Adopter, which offer four colors.
2. **EGA** or Enhanced Graphic Adopter, which offers 16 colors.
3. **VGA** or Video Graphic Array, which offers 256 colors.
4. **SVGA** or Super Video Graphic Array, which offers up to 16 million colors.
5. **XVGA** or Extended Video Graphic Array, which offers up to 16.7 million colors.

### **KINDS OF MONITORS - ACCORDING TO RESOLUTION**

There are two kinds of monitors according to their resolution:

1. High resolution
2. Low resolution

#### **HIGH RESOLUTION**

Good quality of text and graphics on the screen.

#### **LOW RESOLUTION**

Low quality of text and graphics on the screen.

### **KINDS OF MONITORS - ACCORDING TO SCREEN SIZE**

A monitor is available in different screen sizes:

3 to 30 inch screens are available in the market. 15 and 17 inch screens are common now a day.

### **KINDS OF MONITORS - ACCORDING TO VOLUME**

There are two kinds of monitors according to their volume:

1. CRT (Cathode Ray Tube)
2. Flat – Panel Tube

#### **CRT (CATHODE RAY TUBE)**

Monitor of this type screen are used commonly in homes, colleges and offices. These monitors are big and required big area to place, power and have weight more than 10 pounds like TV. We can not move these monitors easily.

#### **FLAT – PANEL TUBE**

These monitors are also available nowadays in market. These monitors are normally used in Laptop computers and we can also use these monitors in desktop computers, there are several types of flat-panel monitors, but the most common is Liquid Crystal Display (LCD).

All of these monitors are widely used today. VGA and SVGA, with high resolution, with CRT and with 15” and 17” of screen size of monitors are fine for most business and home applications.



Figure 2.26  
“CRT Monitor”



Figure 2.27  
Crystal Display (LCD)

## **SPEAKER**

Speaker can be defined as:

“It is a softcopy, standard output device,  
which is used to give the output of sound type of data”

Speakers are known as the Voice Output Devices or Voice Response System. Like monitors, voice response systems provide a temporary, soft copy output.

### **Example:**

Educational applications include "Speak & Spell" trainers.

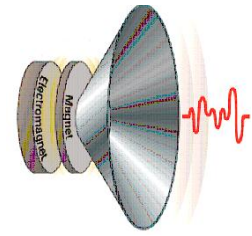

Figure 2.28  
“A Speaker”

## **PC PROJECTOR**

Portable computers are rapidly replacing old fashioned slide projectors and overhead projectors. A PC projector plugs into computer's video output port and projects the video output onto an external surface. These small devices typically weight less that 3kg and can display over 16 million colors at resolution upto 1024 x 1024 dpi (dots per inch). Some PC projectors can be converted from still-video (slides) mode to full-motion video mode, to display output from a VCR or DVD player.



Figure 2.29  
“PC Projector and its usage”

## **HARDCOPY OUTPUT DEVICES**

Following is the list and brief detail of hard copy (permanent) output devices:

1. Printer
2. Plotter
3. Computer Micro File (COM) etc.

### **PRINTER**

Printers can be defined as:

“It is a hardcopy, standard output device,  
which is used to give the color or back and white  
printing of any type of data”

It is also known as primary/standard output device. The output we get from printer is a hard copy output i.e. these are used to get output over a paper. We can make black and white and colored copies with the help of printers. The quality and price of any printer depends upon two factors:

1. Dots per inch
2. Number of characters/words per minute

## **TYPES OF PRINTERS**

There are many types of printers but according to working there are two types of printers:

1. Impact Printers
2. Non-impact Printers

### **IMPACT PRINTERS**

When these printers work their keys strike on ribbon against the paper and leave the impact of keys on the paper to produce the print, like typewriter. Creates an image by using pins or hammers to press an inked ribbon against the paper. These can make carbon copies of the print also while printing.

### **CHARACTERISTICS OF IMPACT PRINTERS**

These printers are:

1. Based on older technology
2. Give effect on paper
3. Cheaper
4. Much noisy
5. Performance is not good
6. Slow in speed
7. Do not have advanced features of printing
8. Can not print multiple pages
9. Can not print on transparencies
10. Can not support for multiple carbon copies
11. Performance is measures in terms of Characters Per Second (cps) or in Lines Per Minute (lpm).

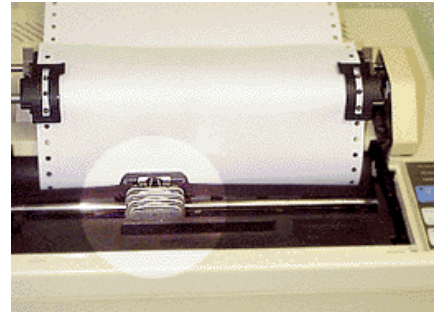

Figure 2.30  
"An Impact Printer Showing  
Detail Of Print Head"

### **TYPES OF IMPACT PRINTERS**

Following are the different types of impact printers (it is also known as the classification of computers with respect to speed):

1. Character Printers
2. Line Printers
3. Daisy Wheel Printers
4. Dot-Matrix Printers

### **CHARACTER PRINTERS**

These print hard copy character by character to complete the whole copy. These can print 10 to 15 characters per second. "Daisy Wheel Printer" is an example of Character printer.



Figure 2.31  
"Character Printers"

### **LINE PRINTERS**

Such printers can print one complete line at a time, in one minute a good line printer can print about 300 to 3000 lines. An example is "Chain Printers" consists of characters on a chain that rotates and print.



Figure 2.32 "A Line Printer"



### **DAISY WHEEL PRINTERS**

This printer has a wheel like the daisy flower, on which various characters are fixed. While printing the daisy wheel moves sideways and characters strike on the ribbon to leave the impact on paper. Electric motor rotates the daisy wheel. It can print 10 to 75 characters per second.

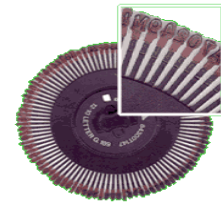

Figure 2.33 "A Daisy Wheel Showing Detail Of The Characters"

### **DOT-MATRIX PRINTERS**

Characters and images are formed from a matrix/sample/pattern of dots. There are several tiny pins, which strike on the ribbon to leave the impact on paper. Number of pins over a matrix varies; there are 9 to 24 pins and can print 50-500 characters per second (cps). This is the cheapest and noisiest of the printer family. The standard of print obtained is poor. These printers are cheap to run and slow in performance.



Figure 2.34 "A Dot-Matrix Printer"

The quality and price of dot-matrix printers depends on two factors:

1. Number of dots per inch termed as DPI (dots per inch)
2. Number of characters or words per minute.

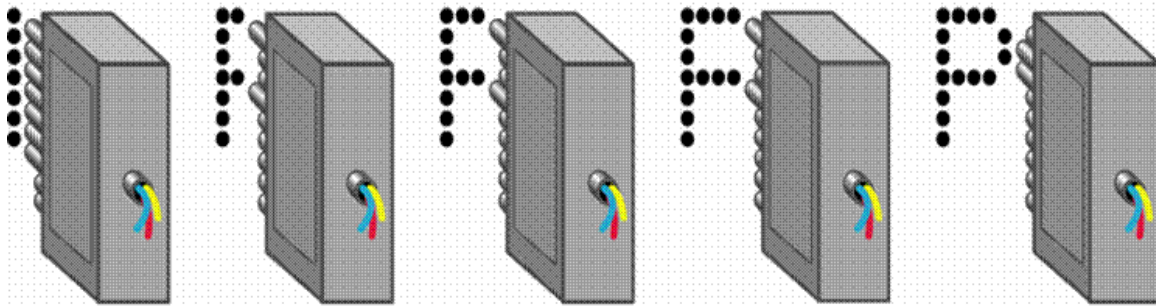

Figure 2.35 "Functionality of a Dot-Matrix Printer"

### **NON-IMPACT PRINTERS**

These printers do not hit or impact a ribbon to print; these are also called page printers, because these can print a full page at a time. These printers move a print head across the page.

### **CHARACTERS OF NON-IMPACT PRINTERS**

There is no ribbon, no striking, therefore:

1. Based on new technology
2. Do not effect on paper
3. Expensive
4. No noisy
5. Performance is very good
6. Faster in speed
7. Have advanced features of printing
8. Can print multiple pages
9. Can print on transparencies
10. Can support for multiple carbon copies
11. Performance is measures in terms of Pages Per Minute (ppm)

## **TYPES OF NON-IMPACT PRINTERS**

Following are the different types of non-impact printers:

1. Ink Jet Printer
2. LASER Printer
3. Thermal Printer
4. Desktop Page Printers (Dye-sub Printers)
5. Fiery Printers
6. Iris Printers

## **INK JET PRINTER**

These printers use the jet of ink to transfer the image of data on paper. They print line by line, making no noise while working. These printers are slower than LASER Printers. They can print 1 to 6 pages per minute and these are almost 4 times greater in cost than LASER Printers and their image have 300-700 dpi (dots per inch). This method of printing allows for good quality, cheap single-color and multi-color printing.

There are two types of ink-jet printers:

1. Monochrome Ink-Jet Printers
2. Color Ink-Jet Printers

## **MONOCHROME INK-JET PRINTERS**

They print only one in color that is they are monochrome. Toner of ink of one color is used in them.

## **COLOR INK-JET PRINTERS**

They use four inks to make a colored output.



Figure 2.36  
"Internal Functionality of an Ink-Jet Printer"

## **EXAMPLES**

1. Ink-Jet Printers
2. Bubble Jet Printers etc.



Figure 2.37  
"An Ink-Jet Printer"

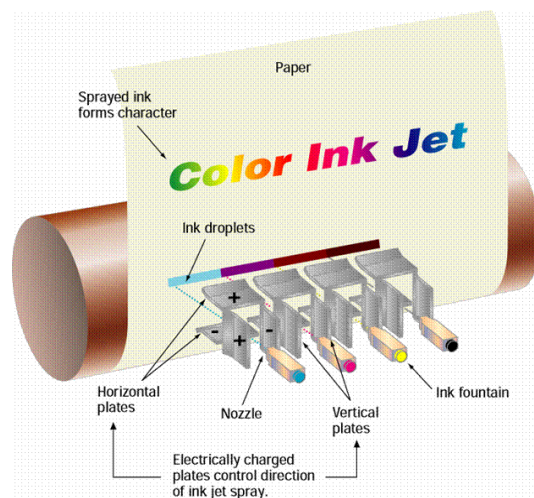

Figure 2.38  
"Functionality of Ink-Jet Printer"

## LASER PRINTER

These printers use LASER Technology to print hard copy. A LASER (Light Amplification by Stimulating Emission of radiation) beam and dry powdered ink to catches the shadow of data and transfer it on paper. The standard of print is very good and laser printers can also produce very good quality printed graphic images too.

### TYPES OF LASER PRINTERS

There are two types of LASER printers with respect to color scheme:

1. Monochrome LASER Printers
2. Color LASER Printers

### MONOCHROME LASER PRINTERS

They print only one in color that is they are monochrome. Toner of ink of one color is used in them.

### COLOR LASER PRINTERS

They use four inks to make a colored output; the printing process is completed only once. Toners of four colors are used in them.

The quality and price of LASER printers depends on two factors:

1. Number of dots per inch termed as DPI (dots per inch)
2. Number of pages per minute.

There are three qualities of LASER printers with respect to image quality and pages per minute:

Type	Dots Per Inch (dpi)	Pages Per Minute
Cheap Quality LASER Printers	600	5-10
Middle Quality LASER Printers	300-1200	10-20
High Quality LASER Printers	600-1200	30-300

Table 2.1  
"Qualities of LASER Printers"



Figure 2.39  
"A1 LASER Printer"

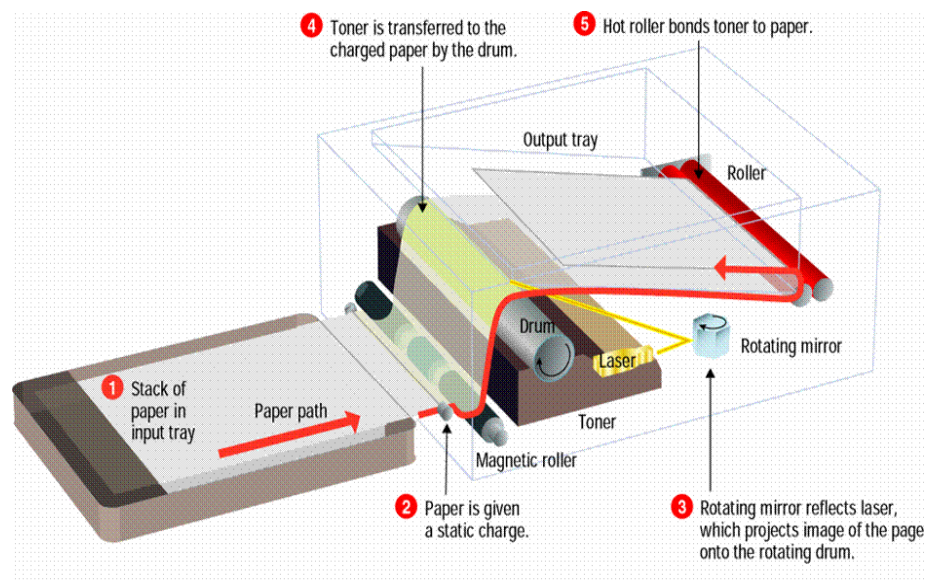

Figure 2.40  
"Functionality of LASER Printer"

### **THERMAL PRINTER**

These are used for color printing. They use a ribbon on which colored wax of four colors is coated. When the printer is used the wax melts and sticks on paper as colored ink, when paper is passed over a heat source. The standard of print produced is poor.



Figure 2.41  
"Thermal Printers"

### **DESKTOP PAGE PRINTERS (DYE-SUB PRINTERS)**

These are used by desktop designers, composers and publishers to produce very high quality of camera read copy.



Figure 2.42  
"Desktop Page Printers"

### **FIERY PRINTERS**

They use digital color copier for printing high quality prints, especially in film industry. They are special purpose printers.



Figure 2.43  
"Fiery Printers"



### **IRIS PRINTERS**

They are used by printing press to produce high quality prints of text and graphics etc.

### **WHAT TO LOOK FOR BUYING A PRINTER**

We need to look following factors while buying a Printer:

1. Speed or output
2. Quality of output
3. Size
4. Multiple carbon copies
5. Expense of ink or toner
6. Initial cost
7. Operational cost



Figure 2.44  
"An Iris Printer"

## **PLOTTER**

These are special purpose hardcopy output devices. These are used for printing on paper like printers, but specially used for printing large size copies like the designs of construction and engineering. Architects, engineers and automobile designers etc. use this kind of printer. These convert digital signals into analog signals to form graphics etc.

### **TYPES OF PLOTTERS**

These are of three types:

1. Pen Plotters
2. Electrostatic Plotters
3. Ink-Jet Plotters

### **PEN PLOTTERS**

These plotters have one or more pens that move over paper back and forth, up and down under the control of computer to produce graphics. Several pens are required to vary the width and color of line and computer selects and uses these pens.

There are further two kinds of Pen Plotters:

1. Flat Bed Plotter
2. Drum Plotter

### **FLAT BED PLOTTER**

In this type the pens move to draw the graphics while the paper is still. A pen holding mechanism is used to draw graphics of considerable length and breadth.

### **DRUM PLOTTER**

In this type a sheet of paper is attached on a drum, which rotates back and forth, right and left while the paper and pens remain still. It is used to produce a continuous output of a design of skyscraper building, aircraft design and earth quack activity etc.

### **ELECTROSTATIC PLOTTERS**

They work like LASER printers, in these plotters the data image light is converted into dots and dots are plotted on to the paper. They work on the principle of dot matrix printer and print across the width of paper. They are monochrome (i.e. single color).



Figure 2.48  
"An Electrostatic Plotter"

### **INK-JET PLOTTERS**

They work on the principle of dot matrix printer; the data image light is converted into dots and dots are plotted in to the paper with jet of ink. The jets of ink are switched on and off at great speed to create multicolor output.



Figure 2.45  
"Pen Plotters"

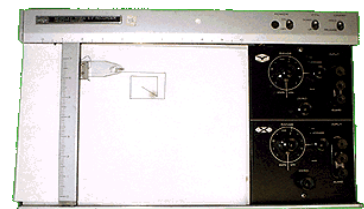

Figure 2.46  
"Flat Bed Plotter"



Figure 2.47  
"A Drum Plotter"



Figure 2.49  
"An Ink-Jet Plotter"

### **COMPUTER MICRO FILM (COM)**

To save a very big amount of data COMs are used. COM, output takes the form of very small images on sheet or rolls of film. A microfilm record can be preserved on rolls of film of size 35mm or on 6x4 inch sheets of film. A microfilm reader can read these records. One COM can store 200 pages.



Figure 2.50  
"COM"

## **2.4 Differentiate Between Impact and Non-Impact Printers**

Ser. No.	Differences	Impact Printers	Non-Impact Printers
1	Technology	Old	New
2	Effect on Paper	Yes	No
3	Noise	More	Nono
4	Cost	Less	More
5	Performance	Bad	Good
6	Speed	Less	More
7	Advanced Features	No	Yes
8	Multiple Carbon Copies	No	Yes
9	Transparencies Support	No	Yes
10	Types	Character Printer, Line Printer, Daisy Wheel Printer, Dot-Matrix Printer	Inkjet Printer, LASER Printer, Thermal Printer, Desktop Page Printer, Iris Printer

## **2.5 Differentiate Between Dot Matrix Printers and LASER Printers**

Ser. No.	Differences	Dot Matrix Printers	LASER Printers
1	Kind	It's a kind of impact printers	Its kind of non-impact printers
2	Technology	Based on old technology i.e. typewriter	Based on new technology i.e. photocpier
3	Effect on Paper	These physically effected on the paper	These are not physically effected on the paper
4	Ink Type	Liquid ink is used	Powder ink is used
5	Print Source	It uses ink ribbon for printing	It uses toner for printing
6	Noise	Creates noise in the environment	Do not creates noise in the environment
7	Cost	These are cheaper	These are expensive

8	<b>Output</b>	Their output of images is blurred	Their output of images is like a real images
9	<b>Performance</b>	Bad performance	Very Good of excellent in performance
10	<b>No of Pages/Characters Per Minute/Second</b>	50-5000 characters per second	30-300pages per minute
11	<b>Speed</b>	Slower in speed of output	Fastest in speed of output
12	<b>Performance Measurement</b>	Performance in measured in terms of Lines Per Minute (lpm) or in Characters Per Second (CPS)	Performance in measured in terms of Pages Per Minute (PPM)
13	<b>Sheets</b>	Normally used continuous paper sheets	Normally used individual paper sheets
14	<b>Advanced Features</b>	Do not have advanced features of printing e.g. Collates, Print on both sides automatically etc.	Have advanced features of printing e.g. Collates, Print on both sides automatically etc.
15	<b>Multiple Carbon Copies</b>	Can not give multiple carbon copies	Can give multiple carbon copies
15	<b>Transparencies Support</b>	Do not print on transparencies	Can print on transparencies
16	<b>Types</b>	Character Printer, Line Printer, Daisy Wheel Printer, Dot-Matrix Printer	Inkjet Printer, LASER Printer, Thermal Printer, Desktop Page Printer, Iris Printer

## **2.6 INPUT-OUTPUT DEVICES (I/O DEVICES)**

There are some devices, which are not so easy to place in a specific class (i.e. an input or an output device). These are the devices that can perform as input devices as well as output devices also known as I/O devices. Such device have the features of both the input and output devices. These devices allow the computer system to interact with the outside world by moving data *into* and *out of* the system.

### **2.6.1 FUNCTIONS PERFORMED BY AN INPUT-OUTPUT DEVICE**

Following are the functions performed by input-output unit:

When a device performs as input unit, it has following functions:

1. It accepts (or reads) the list of instructions and data from the outside world.
2. It converts these instructions and data in computer acceptable form.
3. It supplies the converted instructions and data to the computer system for further processing.

And when a device performs as output unit, it has following functions:

1. It accepts the results produced by the computer which are in coded form and hence cannot be easily understood by us.
2. It converts these coded results to human acceptable (readable) form,
3. It supplies the converted results to the outside world.

### **2.6.2 Examples of Input-Output Devices**

Following is a list of certain input-Output devices about which we will discuss briefly:

1. Processing devices e.g. microprocessor
2. All the memory devices like:
  - i. Primary memory devices RAM, ROM, Registers, Cache memory.
  - ii. Secondary memory devices e.g. Hard disk, floppy disks and drives, Compact disks (CDs) and drives, Digital video disks (DVDs) and drives etc.
3. Network devices like:
  - i. Modem
  - ii. LAN card
  - iii. Switch etc.
4. Terminal
5. Touch Screen Monitors
6. Audio cards
7. Video cards
8. Digital cameras etc

What counts as an I/O device depends on context. To a user, an I/O device is something outside of the system box. To a programmer, everything outside of the processor and main memory looks like an I/O devices. To an engineer working on the design of a processor, everything outside of the processor is an I/O device.

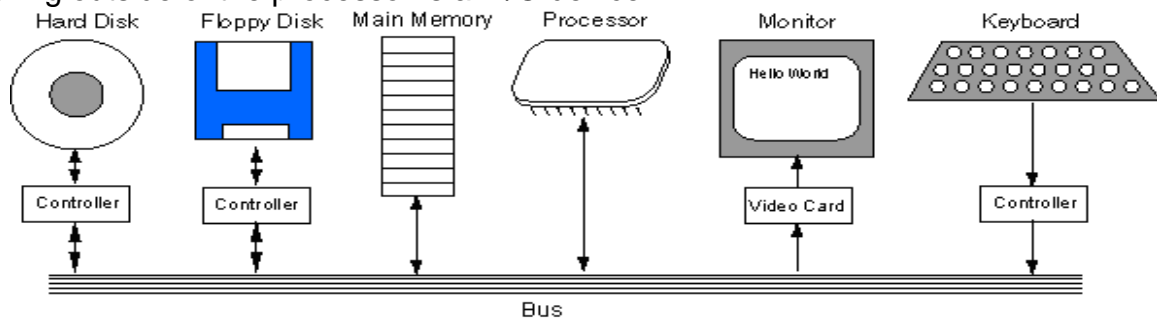

Figure 2.51  
“Main components of a computer system”

The **bus** is a group of wires on the main circuit board of the computer. It is a pathway for data flowing between components. Most devices are connected to the bus through a **controller** which coordinates the activities of the device and the bus.

We will discuss the details of microprocessor, memory and network devices in the later chapters. Here we only discuss some other I/O devices.

### TERMINAL

A terminal consists of a keyboard and a screen so it can be considered an input device, especially some of the specialized types. Some come as single units. Terminals are also called:

1. Display Terminals
2. Video Display Terminals or VDT

A dumb terminal has no ability to process or store data. It is linked to minicomputer, mainframe, or super computer. The keyboard and viewing screen may be a single piece of equipment. An intelligent, smart, or programmable terminal can process or store on its own, at least to a limited extent. PCs can be used as smart terminals.

A point-of-sale terminal (POS) is an example of a special purpose terminal. These have replaced the old cash registers in nearly all retail stores. They can update inventory while calculating the sale.



Figure 2.52  
“A Terminal”



Figure 2.53  
“Point-of-sale Terminals”



These often have special purpose keys.  
For example, McDonalds has separate touchpads for each food item available.

### Touch Screen Monitors:

We have a type of monitors which are known as Touch Screen Monitors. These allow the users to point directly at the computer display, usually to select from a menu of choices on the screen. It's natural to do - reach out and touch something. Most touch-screen computers use sensors in, or near the computer's screen that can detect the touch of a finger. Touch screens are appropriate in environments where dirt or weather would render keyboards and pointing devices useless and where a simple interface is important. Their



Figure 2.54  
"A Touch Screen"

disadvantages are that these are tiring if many choices must be made and these takes a lot of screen space for each choice since fingers are bigger than cursors. Now a days these are normally used with Laptops, PDAs, Screens of machines in petrol pumps, ATMs etc.

There are three forms of Touchscreen:

- i. Pressure-sensitive
- ii. Capacitive surface
- iii. Light beam

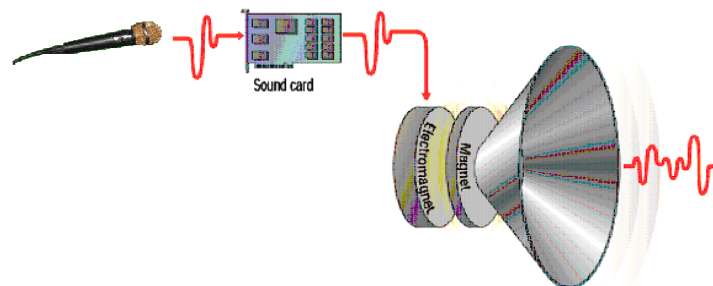

Figure 2.55  
"How Sound Card Works"

### AUDIO/SOUND CARDS

These receives the sound from input line via mic, translates it into digital sounds then into the electric current that is sent to the

speakers via output line. We can use different types of softwares to enhance the capabilities of sound cord or out computer system. These allow computers to produce sound like music and voice. The older sound cards were 8 bit then 16 bit then 32 bit. Though human ear can't distinguish the fine difference between sounds produced by the more powerful sound card they allow for more complex music and music production.

### VIDEO CARDS

These looks like sound card but these allow computers to display video and animation. Some video cards allow computers to display television as well as capture frames from video. A video card with a digital video camera allows computers users to produce live video. A high speed or network connection is needed for effective video transmission.

### DIGITAL CAMERAS

Allow you to take digital photographs. The images are stored on a memory chip or disk and to show on their own screen. The images can be transferred to your computer. Some cameras can also capture sound and video.



Figure 2.56  
"Digital Cameras"

## 2.7 MICROPROCESSOR Or CENTRAL PROCESSING UNIT (CPU)

It is the “Master Hardware” of any computer system.

We have different names for Microprocessor like Processor, Central Processing Unit, CPU, Control Room, Intelligence of the Computer or simple the Brain.

“The computer’s brain which organizes and carries out instructions from either the user or the software”.

A microprocessor is a small IC or integrated circuit built on a tiny piece of silicon and installed on the **motherboard** of computer. It contains thousands, or even millions, of transistors, which are interconnected via superfine traces of aluminum. It is hardware part of the computer.

The transistors work together to store and manipulate data so that the microprocessor can perform a wide variety of useful functions. The particular functions a microprocessor performs are dictated by software to execute programs. **THE CPU SPENDS ALMOST ALL ITS TIME** fetching instructions from memory and executing them. However, the CPU and main memory are only two out of many components in a real computer system.

### 2.7.1 Processor Speed or Clock Speed

Components of a computer (the CPU, memory, adapter cards) are coordinated by a "clock" signal measured in Megahertz (millions of ticks per second) or Gigahertz (billions of ticks per second). The clock tells all the components when they should all be done with their previous operation and when they should begin the next step. With faster processors the clock speed becomes more important. Compared to some of the first computers which operated at below 30 megahertz (MHz) the Pentium chips began at 75 MHz in the late 1990's. Speeds now exceed 3000+ MHz or 3 gigahertz (GHz) and different chip manufacturers use different measuring standards. It depends on the circuit board that the chip is housed in, or the motherboard, as to whether you are able to upgrade to a faster chip. The motherboard contains the circuitry and connections that allow the various components to communicate with each other. In simple, the speed of microprocessor is measured by “how many time it takes to complete one machine cycle”. One Hertz is equal to number of machine cycles completes in one cycle.

1 Hertz = Number of machine cycles completed per second

As it is consider as the brain of the computer. How much intelligent is the brain means how much faster is the computer. Currently the Pentium chip or processor, made by Intel, is the most common CPU though there are many other companies that produce processors for personal computers. Examples are the CPU made by Motorola and AMD. Processing speed of processor specifies that our computer is Pentium-I, Pentium-II, Pentium-III or Pentium-IV.

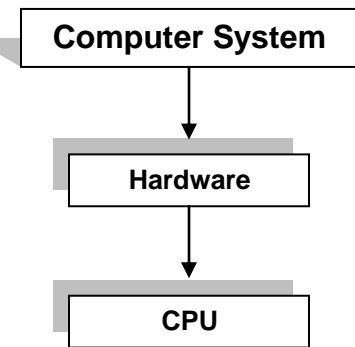

Figure 2.57  
“Hierarchy for CPU/Microprocessor”

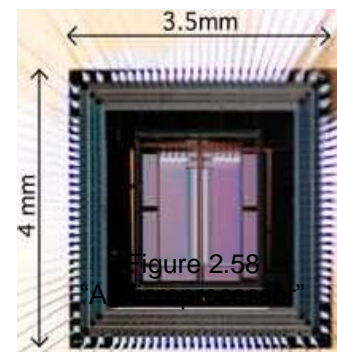

Figure 2.58  
“A Microprocessor”



Figure 2.59  
“Clock”

Microprocessor's Speed		
Model Name	Speed Limit	Front Bus
Pentium-I	100MHz to 233MHz	66MHz
Pentium-II	233MHz to 450MHz	100MHz
Pentium-III	450MHz to 1.3GHz	133MHz
Pentium-IV	1.4GHz to Onwards	400MHz to 800MHz

Table: 2.2

"Representation of computer's models and their speeds"

Intel came out with an entirely new generation of "Prescott" processors that failed to improve performance, so an alternate strategy of "Dual Core" processors has been developed. At present processors are made of silicon and work at atomic level, but in future there will be processors made of Gallium Arsenate that will work at the speed of electron. Speed of electron is the speed of light i.e. 1,86,000 miles per second.

### 2.7.2 Functions of CPU

CPU performs the following main functions:

1. Fetch, means get an instruction or data from Main Memory
2. Decode, translate it into computer commands
3. Execute, means actually process the command
4. Store, means write the results in main memory

Detail of above mentioned functions of CPU can be understood by the study of parts of CPU.

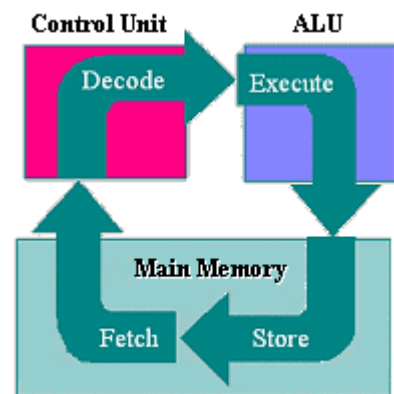

Figure 2.60  
"Functional Cycle of CPU"

### 2.7.3 Major Parts of CPU

The control unit (CU), memory unit (MU) and the arithmetic logic unit (ALU) of a computer system are jointly known as the "central processing unit (CPU)". The CPU is the brain of any computer system. In a human body, all major decisions are taken by the brain and the other parts of the body function as directed by the brain. Similarly, in a computer system, all major calculations and comparisons are made inside the CPU and the CPU is also responsible for activating and controlling the operations of other units of computer system.

### 2.7.4 Functions of Different Parts of CPU

There are three main parts of CPU following are the main functions performed by each part of CPU:

1. Arithmetic and Logic Unit (ALU)
2. Memory Unit (MU)
3. Control Unit (CU)

#### 2.7.4.1 Arithmetic Logic Unit (ALU)

The arithmetic logic unit (ALU) of a

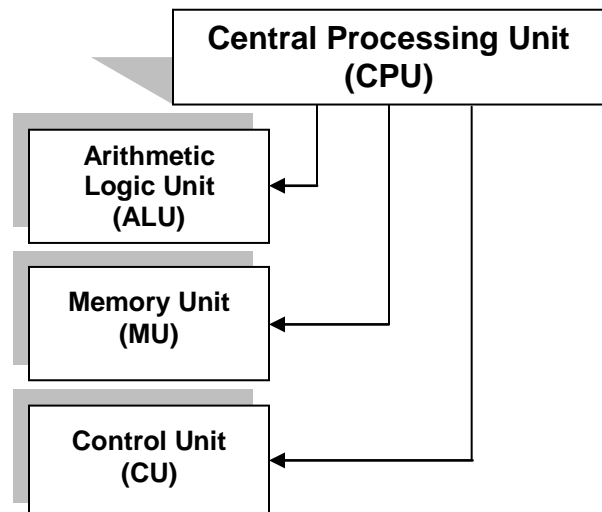

Figure 2.61  
"Major parts of CPU"

computer system is the place where the actual execution of the instructions takes place during the processing operation. All calculations are performed and all comparisons (decisions) are made in ALU. Data stored in primary storage before processing, transferred as and when needed to ALU where processing take place. After processing data transferred to primary storage, so data may move from primary storage to ALU and back again to storage many times before processing is over. After the completion of processing, the final results which are stored in the storage unit are released to an output unit.

Following are the basic functions performed by the arithmetic and logic unit:

1. This is the calculating section of the computer. It performs arithmetic processing like addition, subtraction, multiplication, division exponention.
2. The other function of ALU is to allow the computer system to make decision during the execution of program, called the logical operation or decision like less than, greater than, equal to, not equal to etc.
3. Remember that some of the logical operations/decision making can be done on the text data.
4. It can also compare alphabetic information, such as names or determine whether one name is same as or different from another.

OPERATION PERFORMED BY THE ARITHMETIC LOGIC UNIT	
Arithmetic Operation	Logical Operation
+ Add	=, = equal to, not equal to
- Subtract	>, > greater than, not greater than
* Multiply	<, < less than, not less than
% Divide	>=, <= greater or equal, less or equal
^ Raise by a Power	Compare, AND, OR etc.

Table 2.3  
“Operations performed by ALU”

### 2.7.4.2 Memory Unit (MU)

The memory unit of CPU is the place where the computer program and data are stored during processing. It is a random access storage device consisting of thousands upon thousands of **storage locations**, each of which can be directly reached by the control unit. Each storage location is distinguished by a unique number called its **Address**. During a processing procedure, different data may be stored in any given storage location, but the address of the storage location is fixed. For example: the memory unit is often compared to a post office. At various times different letters are placed in a postal box, but the box number is always the same.

Following are the basic functions performed by the memory unit:

1. Having all the data to be processed and the instructions required for processing (received from input devices).
2. Having intermediate results of processing.
3. Having final results of processing before these results are released to an output device.

### 2.7.4.3 Control Unit (CU)

It is the control unit who tell the input unit that it is time for it to feed data into the memory unit. It also handles ALU to tell what should be done with the data when it receives it.

Control unit is also responsible to send only the final results to output device not the intermediate results. It is the responsibility of control unit to maintain order and direct the operation of the entire system. Although, it does not perform any actual processing on the data, the control unit acts as a central nervous system for the other components of the computer. It manages and coordinates the entire computer system. It obtains instructions from the program stored in main memory (RAM), translate the instructions, and issues signals that cause other units of the system to execute them.

Following are the basic functions performed by the control unit:

1. It is like a traffic policeman controlling the movements of vehicles on the road. Control unit controls the flow of data inside the computer system. It is the “nervous system” of the machine. It coordinates and controls the computer system just as the brain directs the body. It does not execute the instructions itself but instead directs other parts of the computer system to do so.
2. It controls all the units/devices or parts of computer system directly or indirectly. It obtain instructions from the internal memory unit. After interpreting, the control unit transmits directions to the appropriate components of the computer. Ordering them to perform the required operations.
3. Directly control to ALU and MU.
4. Indirectly control to input and output units.
5. The control unit tell the input device and secondary storage device what data and instructions to read into memory, tell the ALU where the data to be processed, what operations to perform on data, where in memory the results are to be stored and finally, it directs the appropriate output devices to convert processed data into human readable form. After an instruction is executed the control unit proceeds to the next instruction.
6. How i/o devices knows that its time to get data from computer or enter data to system this is done by cu.
7. Only final results of an execution is send to out put devices
8. It manages the order of execution.

## 2.8 MEMORY

If we want to use anything again and again we save the thing at any place or we memorize the thing. In computer if we want to use any data again and again we store it in the computer memory. When we give instructions to a computer, it goes to the memory of the computer and from the memory; the computer reads the instructions.

“When you launch a program, it is loaded into and run from memory”

Or

“Memory is the electronic or magnetic holding place for instructions and data that our computer's microprocessor can reach quickly”

In simple we can say that “memory is the power of remembering”, if we talks about computer's memory, it means that it is the power of computer to remember its data or the computer's memory is used to store data and instructions. We have different types of

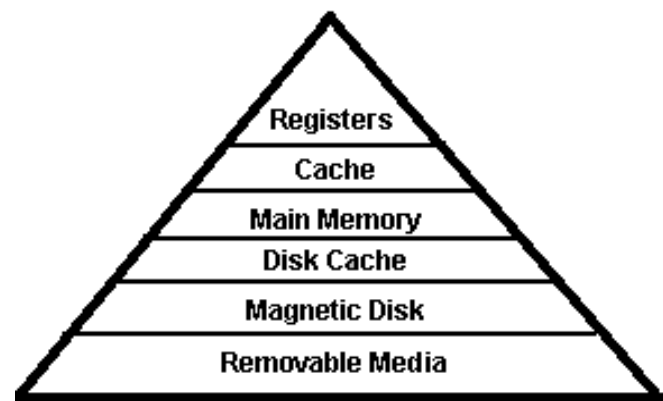

Figure 2.62  
“Memory Hierarchy”

memories in computer system. Some memories are cheaper but slower in performance but more in a size or amount while the other memories are expensive in nature but faster is data accessing speed and smaller in size. Following is a hierarchical figure which shows us the difference among different types of computer memory. More expensive, faster and lesser in size memories are higher in hierarchy while less expensive, slower in performance and more in size memories are lower in hierarchy.

### 2.8.1 Units to Measure Memory

When we want to measure length of any thing we use meter or foot as a measurement unit. And to measure memory of computer, we have different units to measure computer's memory. Bit is the smallest unit, used to measure computer memory. The other and most common unit for the measurement of computer's memory is Byte, one byte hold 8-bits and it holds one character.

Following is the table containing the "measuring units of memory" these are also known as the "**memory units**" or "**storage units**".

Unit Name	Unit Symbol	Unit Size
Bit	b	-
Nibble	N	4-Bits
Byte	B	8-Bits
Kilo Byte	KB	1024-Byte
Mega Byte	MB	1024-Kilo Byte
Giga Byte	GB	1024-Mega Byte
Tera Byte	TB	1024-Giga Byte
Peta Byte	PB	1024-Tera Byte
Exa Byte	EB	1024-Peta Byte
Zetta Byte	ZB	1024-Exa Byte
Yotta Byte	YB	1024-Zetta Byte

Table 2.4  
"Measuring Units of Computer Memory"

### 2.8.2 TYPES OF MEMORY

Basically a computer has two types of memory or storage devices:

1. Primary memory or Primary storage devices
2. Secondary memory or Secondary storage devices

Following is a figure which describes the memory and its types:

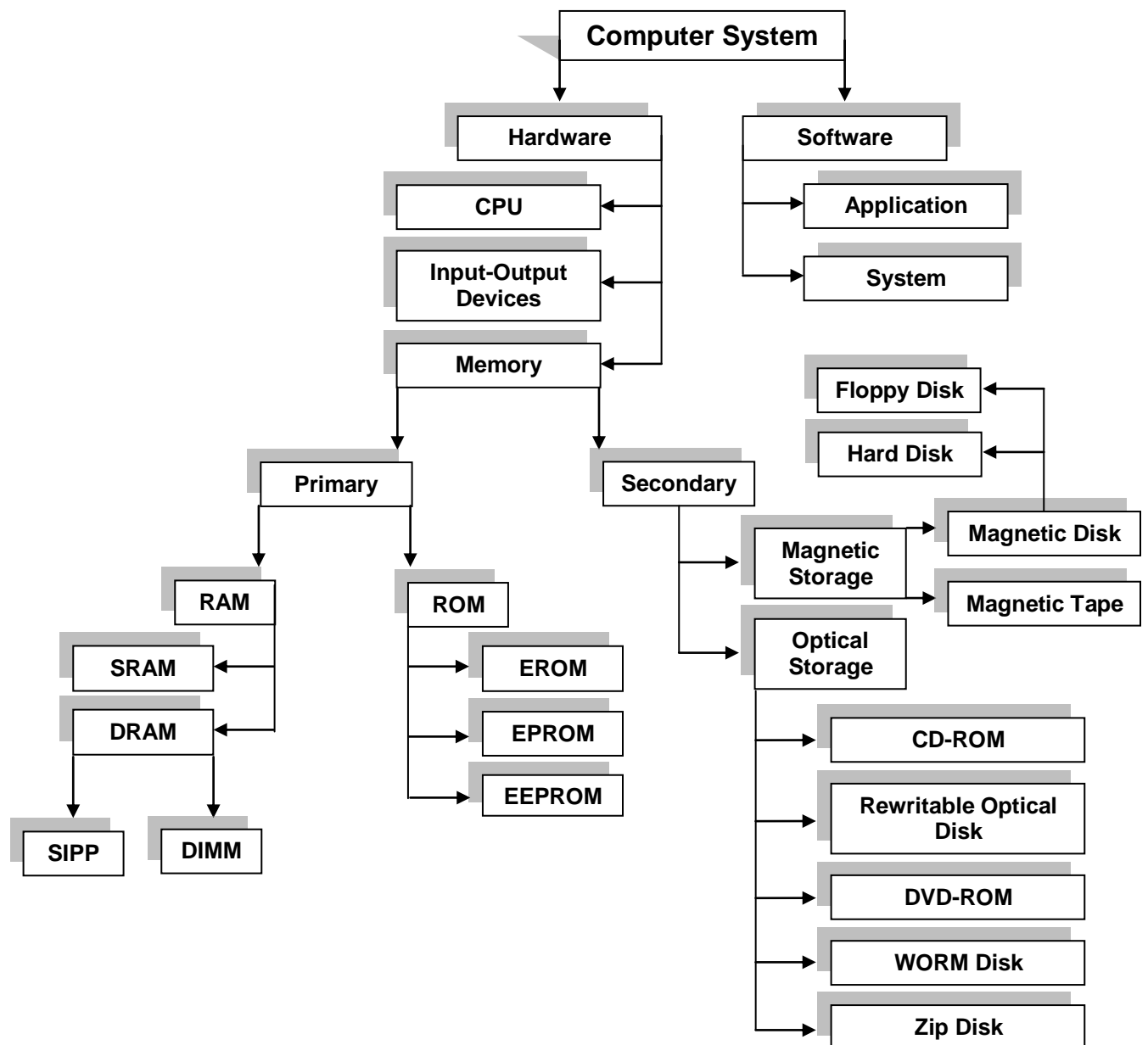

Figure 2.63  
“Hierarchical Representation of Computer Memory”

### 2.8.2.1 PRIMARY MEMORY OR PRIMARY STORAGE DEVICES

It is also known as the *main memory* of computer. The data stored in this type of memory is of temporary nature and stays in memory until processing. As this memory is costly so its size is limited than the secondary memory. Devices which are used to store primary memory are called the “*primary storage devices*”. This memory holds the much lesser amounts of data that that is of immediate need. The data access speed is faster in Primary memory or in Primary Storage devices, as there is the involvement of electricity.

#### CHARACTERISTICS OF PRIMARY MEMORY

Following is a brief list for the characteristics of Primary Memory:

1. These are normally temporarily in nature e.g. RAM but some times these are also permanent e.g. ROM.
2. It is costly in nature.

3. It is faster in data accessing speed.
4. Its size in any computer system is lesser than the Secondary memory.
5. It is electrically in nature.
6. Also known as the Main memory, Volatile memory or Primary storage of computer system.
7. Help in execution of programs and instructions.
8. These are closely related to processor.
9. Having the data actively using by the processor.
10. Interacts with processor millions of times per second.
11. Here data is not organized into files.

### **TYPES OF PRIMARY MEMORY**

There are two types of primary memory:

1. Random Access Memory (RAM)
2. Read Only Memory (ROM)

### **RANDOM ACCESS MEMORY (RAM)**

It is a kind of Primary or Main memory, which is also a *Temporary memory*. It is installed in the form of chips on motherboard and links directly to the processor. When the power of computer is switched off, all the data present in this memory is washed off, so it is also referred as *Volatile memory*.

It is possible to randomly select and use any location of this memory to directly store and retrieve data and instructions. Before the execution of a program, all the data or program instructions must be transferred



Figure 2.64:  
"RAM"

from input devices or from secondary storage devices to RAM, and reached to processor for processing. When one program has been executed and data processed, then the storage space of RAM is occupied by another program which is waiting for its execution and so on.

This memory is also known as the *Read/Write memory*, as we can read and write data in this type of memory, the users or computer operators read and write in this memory so it is also known as the "*User's memory*".

### **CHARACTERISTICS OF RAM**

Following is a brief list for the characteristics of RAM:

1. All the programs and instructions must be loaded in RAM before going to or coming from Processor.
2. Directly link to Processor.
3. It is temporary memory, when we turn off the computer, the contents of this memory are washed and information stored in RAM is lost.
4. This memory is called Volatile because contents of this memory can be changed.
5. We can read, write and delete information from RAM.
6. It is also known as "user's memory".
7. Its installation is not so easy but as compare to ROM it can be easily installed or remove from motherboard.
8. No special programming skills are required to write data on it.
9. Data and instructions are continuously changeable in it.
10. Data and instructions are written into it at the time of execution.



11. It has fast speed.
12. It is cheaper as compare to ROM.
13. The technology, which is nowadays used for RAM, is CMOS (Complementary Metal Oxide Semiconductor).
14. This memory consists of small blank chips. Blank memory chips are fixed on a, Single Inline Memory Modules (SIMM) or on Double Inline Memory Module (DIMM). Basically these are the circuit boards, which can hold a group of memory chips.

### **TYPES OF RAM**

There are two types of RAM:

1. Dynamic Random Access Memory (DRAM)
  - i. Single inline pin package (SIPP)
  - ii. Single inline memory module (SIMM)
  - iii. Dual inline memory module (DIMM)
2. Static Random Access Memory (SRAM)

### **DYNAMIC RANDOM ACCESS MEMORY (DRAM)**

It is a popular type of RAM and is mostly used in computers. DRAM needs to refresh many times in a second that is why it is slow. However it is cheaper, easily available and requires less power. In newer microcomputers, most of the main memory consists of DRAM chips which have an access time of 80 to 120 nanoseconds. Its main purpose is to decrease the processing cost.

### **STATIC RANDOM ACCESS MEMORY (SRAM)**

Static RAM is not so popular but it is faster than DRAM because it does not need to refresh hundreds of times in a second like DRAM. It is much more expensive, and requires more space and power than DRAM. In newer microcomputers, a small portion of the memory (32 or 64 bytes) uses much more expensive SRAM chips, which have an access time of 25 to 35 nanoseconds. Its main purpose is to decrease the processing time.

### **READ ONLY MEMORY (ROM)**

This is also called the BIOS (Basic Input/Output of System). It is also a kind of Primary or Main memory, so it is also a faster memory. It is *Permanent memory*, as the data or information stays permanently. The users or computer operators can not (normally) change the information present in this type of memory but they can only read the information present in this memory, so it is also referred as *Read only memory*.



Figure 2.65  
"ROM"

This memory contains the detailed information about hardware and softwares present in computer system so it is also called as *System's memory* and the information stored in ROM at the time of manufacturing. Computer system used the ROM at the time of booting (starting) process. During booting, computer reads from ROM what to do. It contains the set of start-up instructions that check rest of memory is functioning properly, check for hardware devices and check for an operating system on the computer and disk drives.

When we turn-off the computer, information stored in ROM does not washed out, that why it is called as *Permanent or Non-volatile memory*. It is installed in the form of chip on the motherboard or mainboard.

## **CHARACTERISTICS OF ROM**

Following is a brief list for the characteristics of ROM:

1. Having the information about hardware and software of the computer system.
2. Indirect link to the processor.
3. It is permanent memory. Information remains stored in it. Even the computer is turn off.
4. This memory is also called non-volatile because we cannot modify its contents.
5. Now we can read, write and delete information from ROM but it has special software, programming skills and hardware requirements.
6. It is also known as “system’s memory”.
7. Special programming skills are required to write data on it.
8. It is slower in processing.
9. Data and instructions are not continuously changeable in it.
10. Data and instructions are written into it at the time of manufacturing.
11. It is expensive in nature as compare to RAM.
12. This memory contains BIOS (Basic Input Output of System). And based on semiconductor technology.
13. This memory is also called firmware because manufacturer of the computer produces this memory.

## **TYPES OF ROM**

There are three types of ROM:

1. Programmable Read Only Memory (PROM)
2. Erasable Programmable Read Only Memory (EPROM)
3. Electrically Erasable Programmable Read Only Memory (EEPROM)

### **PROGRAMMABLE READ ONLY MEMORY (PROM)**

PROM provides the facility to programmer to change the contents of ROM once. When once something is written on it and saved in PROM. It becomes ROM.

### **ERASABLE PROGRAMMABLE READ ONLY MEMORY (EPROM)**

In EPROM, contents can be written, saved and changed for two times, after that it also becomes the ROM.

### **ELECTRICALLY ERASABLE PROGRAMMABLE READ ONLY MEMORY (EEPROM)**

In EEPROM, the contents can be written, saved and changed as many times as the programmer wish for that.

## **2.8.2.2 SECONDARY MEMORY OR SECONDARY STORAGE DEVICES**

It is also known as the *auxiliary memory* or *auxiliary storage* or *permanent memory* of computer. The data stored in this type of memory is of permanent nature and stays in memory permanently. As this memory is cheap so its size is more than the primary memory. Devices which are used to store secondary memory are called the “*secondary storage devices*”. This memory holds the much larger amounts of data that won’t fit into RAM and may not be immediately needed. The data access speed in Secondary memory or in Secondary Storage devices is slower as compare with Primary memory or in Primary Storage devices, because there is the involvement of magnetism.

## **CHARACTERISTICS OF SECONDARY MEMORY**

Following is a brief list for the characteristics of Secondary Memory:

1. These are normally permanent in nature e.g. simply ROM but some times these are also temporary e.g. PROM, EPROM and EEPROM.
2. It is cheaper in nature.
3. It is slower in data accessing speed.
4. Its size in any computer system is more than the Primary memory.
5. It is magnetic and optical/electromagnetic in nature.
6. Also known as the auxiliary memory, secondary storage or backup memory of computer system.
7. Help in storing of programs and instructions.
8. These are not closely related to the processor.
9. Having the data not actively using by the processor.
10. Do not interact with processor millions of times per second.
11. Here data is organized into files.

### **TYPES OF SECONDARY STORAGE DEVICES**

Secondary storage devices are also used for backup of data. Some common Storage devices are as follows:

1. Magnetic Storage Media:
  - i. Magnetic Tape Storage
  - ii. Magnetic Disks Storage
    - a. Hard Disks
    - b. Floppy Disks
2. Optical Storage Media:
  - i. CR-ROM
  - ii. Rewriteable Optical Disk
  - iii. DVD-ROM
  - iv. WORM Disk
  - v. Zip Disks etc.

### **MAGNETIC TAPE STORAGE**

It looks like the music cassettes with magnetic coating. In magnetic tape data is stored as extremely small magnetic spots. Usually half ½ inch wide or ¼ inch wide tape are available. The amount of data measured in terms of CPI (characters per inch) BPS (bytes per inch).

Magnetic tape contains tracks on which data is stored. Magnetic tape unit is used to read and write on tape. Usually the length of ribbon is 90 meters. The speed of the same tape unit is upto 200 inches per second. The unit in which the tape disk is inserted is called "Tape Drive". In the tape disk the data is stored in the data is stored in shape of record. Blank spaces are given after every record to separate the records, there blank space are called Inter Record Gaps (IRG) or Inter Block Gaps (IBG).



OPEN REEL

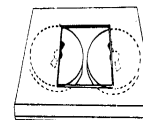

CARTRIDGE

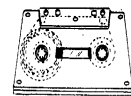

CASSETTE

or

Figure 2.66  
"Magnetic Tape"

### **MAGNETIC DISK STORAGE**

Magnetic disks are most popular medium of direct-access secondary storage. Data can be accessed directly from any where of the magnetic disk. Data reading and writing speed on a magnetic disk is many times faster than a magnetic tape. A magnetic disk is a thin, circular metal plate/platter coated on both sides with a magnetic material.

## **STORAGE OF INFORMATION**

In a disk pack, information is stored on both the surface of each disk plate except the upper surface of the top plate and the lower surface of the bottom plate, which are not used. Each disk consists of a number of invisible circles called **Tracks**. A set of corresponding tracks in the entire surface is called **Cylinder**. Tracks on a disk are split up into **Sectors**. On a floppy disk, sectors on the disk are not present before the disk is formatted for the first time but are defined after it has been formatted.

The information stored on a disk can be read many times without affecting the stored data. So the reading operation is non-destructive. But the writing of new data erases data previously stored at that location of the disk where we write new data. As soon as the disk receives a read/write commands, the read/write heads are first positioned on to the specified track number by moving the arm assembly in the proper direction and then start reading from the specified track.

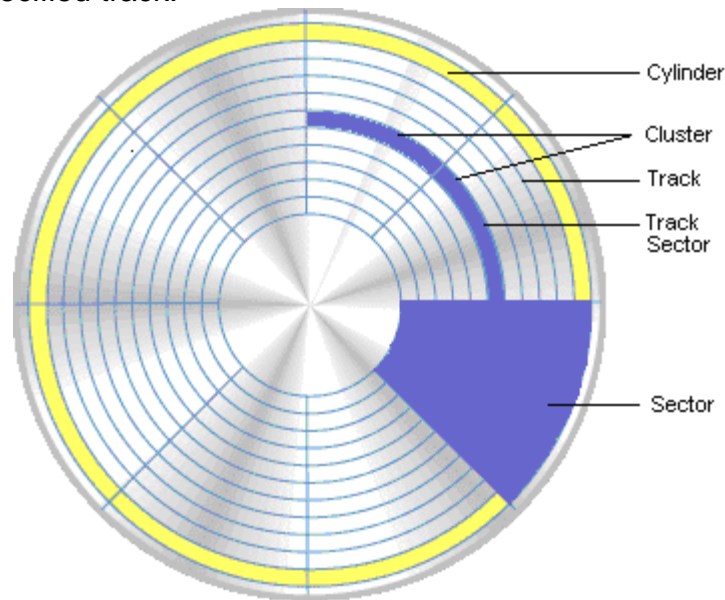

Figure 2.67  
"Internal Structure of a Magnetic Disk"

## **TYPES OF MAGNETIC DISK**

Following are the two main and common types of magnetic disk:

1. Hard disk
2. Floppy disk

### **HARD DISK**

Hard disks were invented in the 1950s and they started out as large disks up to 0.5 metres in diameter holding just a few megabytes. They were originally called "fixed disks" or "Winchesters" (a code name used for a popular IBM product). They later became known as "hard disks" to distinguish them from "floppy disks."

Hard disk is a stack of one or more metal platters that turn on the one spindle. Each platter is coated with iron oxide and the entire unit is enclosed in sealed hole. A hard disk consists of platters, the motor that spins the platters and a set of read write heads with arms. Platters of the hard disk are made up of strong metal (usually aluminum) and coated with magnetic element like Cobalt etc. The hardness of the hard disk allows it to spin much faster than a floppy disk. Hard disk provide us big area for storing data. According to

accessing speed of data , hard disk is very fast as compare to floppy disk. A hard disk is fixed in computer and we can write, read and delete data from it. We can store data permanently in hard disk. Hard disk spins continuously at a great speed of 3600rpm, 6000rpm, 7200rpm etc .The storage capacity of hard disk depends on the tracks per inch of surface and bits per inch of track. Different capacities of hard disk are available in market, for example: 1GB, 2GB, 4GB, 10, GB, 20GB, 40GB etc.

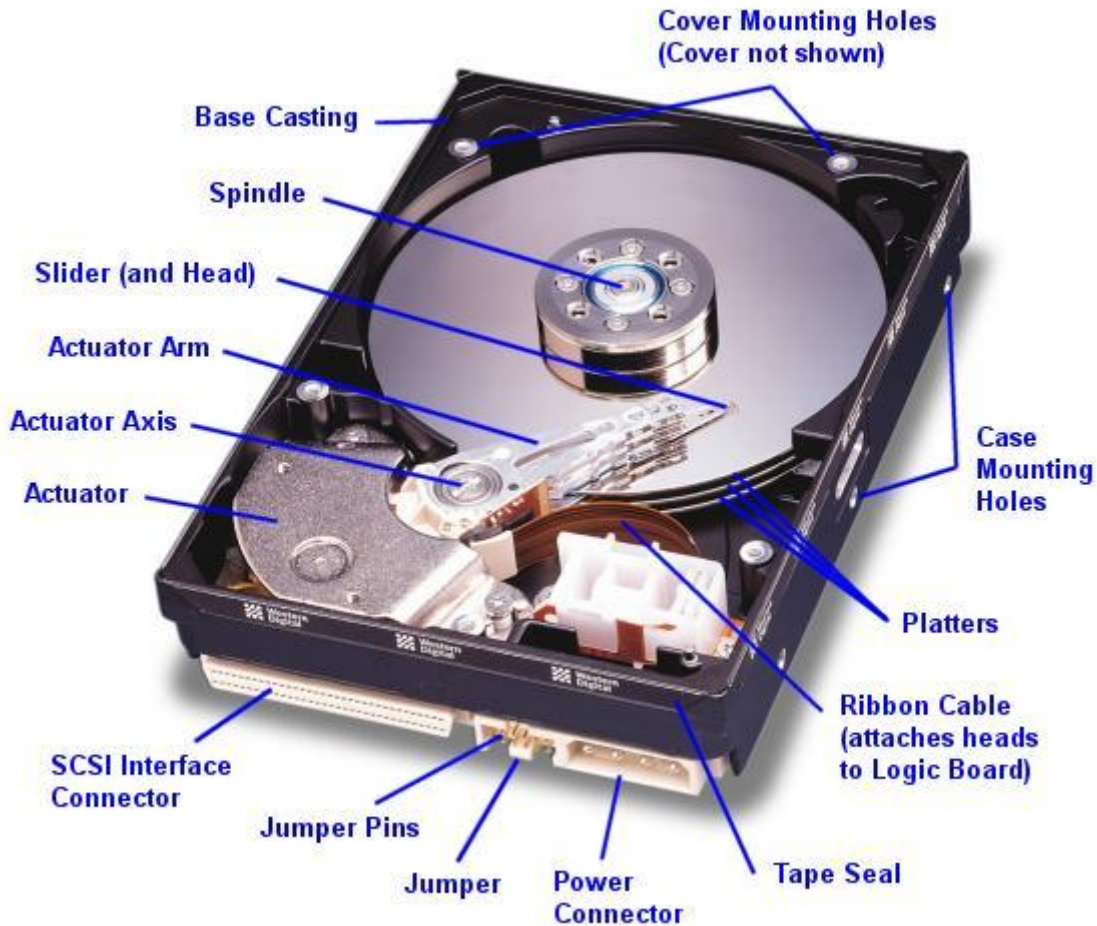

Figure 2.68  
"Internal Structure of a Hard Disk"

There are two ways to measure the performance of a hard disk:

1. The data rate - the number of bytes per second that the drive can deliver to the CPU. Rates between 5 and 40 megabytes per second are common.
2. The seek time - the amount of time it takes between the time that the CPU requests a file and the first byte of the file starts being sent to the CPU. Times between 10 and 20 milliseconds are common.

The other important parameter is the capacity of the drive - the number of bytes it can hold.

### **FLOPPY DISK**

Floppy disks are also known as diskette or floppies. They were introduced by IBM in 1972 and now being produced in by various sizes and by various manufacturers. A floppy disk is made up of flexible plastic which is coated with magnetic oxide. These



Figure 2.69  
3.5 Floppy Diskettes

disks are enclosed in square jacket of plastic. Usually floppies are used to transfer small amount of data from one computer to another computer.

According to size or capacity, floppy disks are lesser than the hard disk, because these always consist of one platter. Floppy disks are also slower in performance as compare with the hard disks and are inexpensive.

### **AVAILABLE SIZES AND CAPACITIES**

Floppy disks are available in two sizes:

- a. 3.5 inch
- b. 5.25 inch

Both of them are available in double density and high density storage capacities, which is shown in the following table:

Size	Density	Capacity
5.25"	Double	360KB
5.25"	High	1.2MB
3.5"	Double	720MB
3.5"	High	1.44MB

Table 2.5

"Sizes of Floppies According to Density and Capacity"

Floppy disks are not reliable storage medium and we can not store large amount of data on a floppy disk permanently.

Floppy drives are used to read, write or delete data on floppy disks.



Figure 2.70  
"Floppy Drive"

### **OPTICAL STORAGE**

Following is the brief detail of commonly use Optical Storage Devices:

#### **CD-ROM**

CD-ROM stands for "compact disk-read only memory". It is new technology of storage media as compare to floppy disks. It is made up of flexible material such as plastic etc. it can be written once and can be read so many times, but its contents can not be changed.

The storage capacity of CD-ROM's is more than the floppies but less than the hard disks, these are available in different capacities, for example: 680MB to 1GB.

"Optional Laser Disk" technology is used to read and write data on it with the help of two laser beams. One beam is used to write while the other is used to read data from it. Data is stored on its surface in the form of pits and lands. Pits are tiny areas that are burnt with laser, land is flat areas and together they record data in the form of binary digits (0 or 1).

CD-Writer is a device used to write data on to the CD. CD-Drive or CD-Player is needed to play the CD.



Figure 2.71  
"Compact Disks (CDs)"

### **REWRITEABLE OPTICAL DISK**

Magnetic and optical technologies are used together in this disk that enables to read and write on it so many times. Its size is 5.25 inch, and can store up to one GB of data. These are replacing hard disks.

### **DVD-ROM**

DVD-ROM stand for “Digital Versatile Disk Read Only Memory”. It is a new development that has dramatically increased the storage capacity of data. It offers high quality of audio and video. It can store up to 2GB of data. It uses short wave length of LASER to read and write data on it. It has two tracks each for audio and video, it makes full use of each track to give high quality of audio and video. It was first used in Holly Wood Film Industry.

### **WORM DISK**

It stands for “Write Once Read Many”. It is a disk like CD-ROM, but it can store grater amount of data. It is used in workstations and super computers. This can store up to 200GB of data. Famous libraries uses it to store digitized versions of books. It has life more than 30 years.

### **ZIP DISKS**

ZIP disk is the invention of new technology which is the combination of Optical and Magnetic technology. It has 3.5 inch of size and looks like a floppy disk, but we can store large amount of data i.e. up to 120MB in it. ZIP disk is a reliable storage medium and easily movable. We can move larger amount of data through ZIP disks. ZIP drives are used to run ZIP disks.



Figure 2.72  
“Zio Disk”

## **2.8.3 SPECIAL MEMORIES**

We have different types of fast and slow memory in computer system as shown in following hierarchical diagram:

This figure shows us that difference among different types of computer memories. More expensive, faster and lesser in size memories are higher in hierarchy while less expensive, slower in performance and more in size memories are lower in hierarchy.

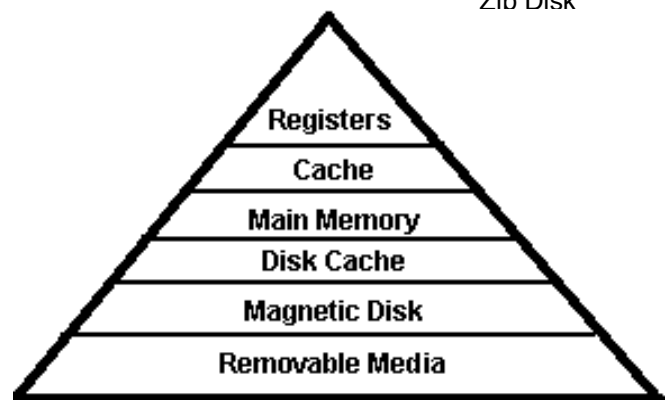

Figure 2.73  
“Memory Hierarchy”

### **2.8.3.1 TYPES OF SPECIAL MEMORY**

Following are the two main types of special memory:

1. Registers Memory
2. Cache Memory

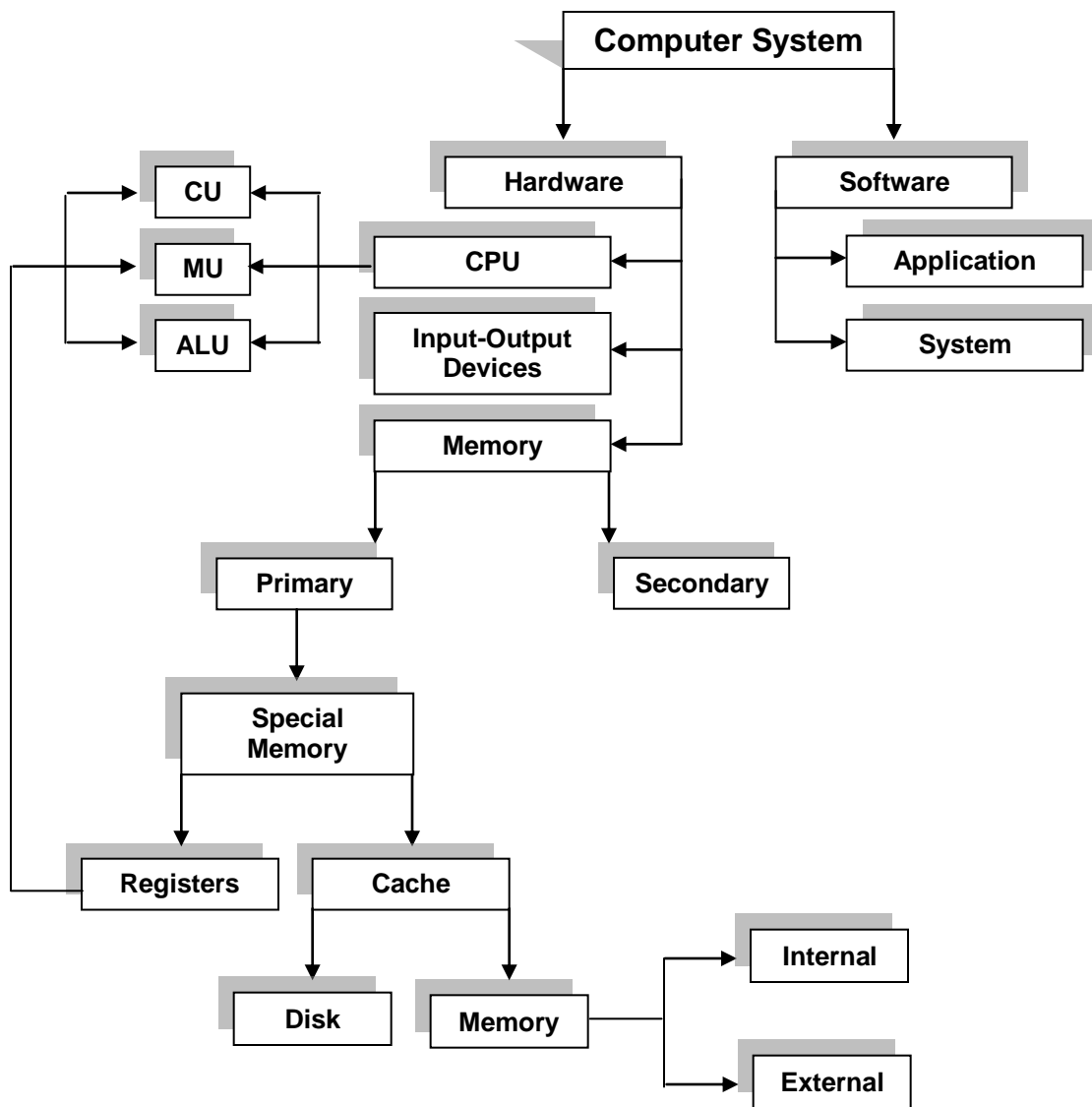

Figure 2.74  
 “Hierarchical Representation of Special Memory in Computer System”

Registers and Cache memories are considered as the special memories in the computer system. Following is the description about special purpose memories of computer system:

### **CACHE MEMORY**

Cache memory can be defined as:

“It is a special type of primary memory, which is used to decrease the processing time and increase the efficiency of CPU”

Programs and data are loaded from secondary storage devices to RAM because the time required to access them from RAM is much less than to access them from secondary storage devices. Nothing happens in computer system until data and programs are transferred from RAM to processor, there is a difference of data accessing speed between RAM and the processor. To fulfill such difference cache memory is being in use.



It is pronounced as “cash” and also known as “high Speed Buffer”. It is a special high-speed storage mechanism. It can be either a reserved section of main memory or an independent high-speed memory chips.

In newer microcomputers, most of the main memory consists of DRAM chips which have an access time of 80 to 120 nanoseconds. A small portion of the memory (32 or 64 bytes) uses much more expensive SRAM chips, which have an access time of 25 to 35 nanoseconds. SRAM is by nature faster than DRAM and unlike DRAM, does not need to be “refreshed” or regenerated before being read. The result is almost instantaneous access, so that the processor is not kept waiting for data. To use cache successfully, the system has to anticipate

which data will be needed next, and try to ensure that it is in cache when needed. When data is needed, the system looks in cache first and then in the slower DRAM. The higher the number of “hits”, when the data needed is actually in the cache when requested, the faster the system will be. There are statistical procedures used by cache controllers to decide which items to hold in cache. Above figure shows the environment of data accessing of Processor and the Main memory (RAM)

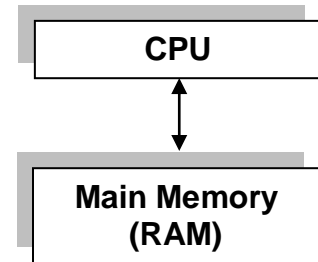

Figure 2.75  
“Before Cache”

### **CHARACTERISTICS OF CACHE MEMORY**

Following is a brief list for the characteristics of Primary Memory:

1. It is the small part of Main memory of computer system.
2. It is temporary memory.
3. Its data accessing speed is faster than Ram but slower than Processor’s memory.
4. Cache memory makes main memory appear to be faster and larger than it really is.
5. It is electronically in nature.
6. It is very expensive as compared to the main memory and hence it is normally very small.
7. Its size in any computer system is lesser as compared with RAM or Secondary memory.
8. The most important effect of cache memory is in improving the memory transfer rates and thus raising the processor speed.

### **TYPES OF CACHE MEMORY**

Two types of caching are commonly used in personal computers:

1. Memory caching
2. Disk caching

### **MEMORY CACHE**

A memory cache, sometimes called a cache store or RAM cache, is a portion of memory made of high-speed static RAM (SRAM) instead of the slower and cheaper dynamic RAM (DRAM) used for main memory. Memory caching is effective because most programs access the same data or instructions over and over. By keeping as much of this information as possible in SRAM, the computer avoids accessing the slower DRAM.

Some memory caches are built into the architecture of microprocessors. The Intel 80486 microprocessor, for example, contains an 8K memory cache, and the Pentium has a 16K cache. Such internal caches are often called **Level 1 (L1) caches**. Most modern PCs also come with external cache memory, called **Level 2 (L2) caches**. These caches sit between the CPU and the DRAM. Like L1 caches, L2 caches are composed of SRAM but they are much larger.

The data in the form of “Words” transfer from Memory Cache to CPU while data reaches to Memory cache form Main memory (RAM) in the form of “Blocks”, this is so to save the time and resources of the computer system.

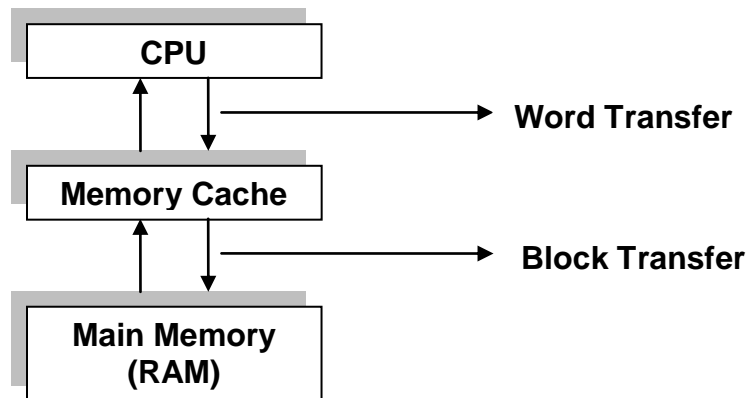

Figure 2.76  
“After Cache”

### TYPES OF MEMORY CACHE

There are two types of memory cache. This is only to speedup the job of data processing and to facilitate the users of the computer system:

1. Internal Cache
2. External Cache

#### INTERNAL CACHE

To increase the data accessing speed or to minimize the clock time from Memory cache to CPU or form CPU to Memory cache, another cache memory known as **Internal Cache** (Cache 1) is installed between CPU and Memory Cache, so CPU’s control first check the Internal Cache for required instructions or data if it is not found the required material in Internal Cache then control goes to Memory cache. The internal cache is faster than Memory cache.

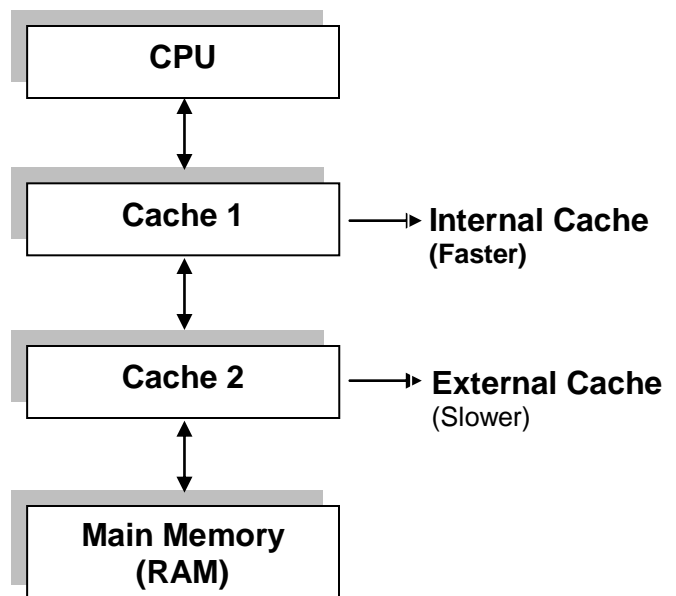

Figure: 2.77  
“Relationship Among CPU,  
Internal Cache, External Cache and RAM”

#### EXTERNAL CACHE

To speed up all this one more cache memory is inserted between CPU and the Memory Cache. That was between Internal Cache and the Main memory (RAM) of the computer system called the **External Cache** (Cache 2). The speed of External Cache is more than the Ram but less than the Internal Cache. The reason was to increase the data accessing speed or to minimize the clock time or to facilitate the computer user.

#### DISK CACHE

Disk caching works under the same principle as memory caching, but instead of using high-speed SRAM, a disk cache uses conventional main memory. The most recently accessed data from the disk (as well as adjacent sectors) is stored in a memory buffer. When a

program needs to access data from the disk, it first checks the disk cache to see if the data is there. Disk caching can dramatically improve the performance of applications, because accessing a byte of data in RAM can be thousands of times faster than accessing a byte on a hard disk.

When data is found in the cache, it is called a **cache hit**, and the effectiveness of a cache is judged by its hit rate. Many cache systems use a technique known as smart caching, in which the system can recognize certain types of frequently used data. The strategies for determining which information should be kept in the cache constitute some of the more interesting problems in computer science.

### **RELATIONSHIP AMONG CPU, CACHE, MAIN AND SECONDARY MEMORIES**

If CPU needed certain data first of all it checks its required material in Internal Cache, if CPU gets its requested details, its good other wise CPU contacts with External Cache, if requested material finds at this point CPU don't request any other memory or part, other wise control transfer to Memory Cache and if requested material finds here, its ok else CPU's control transferred to Main memory (RAM), now if the requested material is here, it will be good otherwise CPU's control will be transfer to Disk Cache, if getting requested material here, CPU will stop transferring its control else control will be transfer to Secondary memory (Hard disk or Floppy Disk), to get the required data or instruction, other wise CPU will generate an error message. Above figure shows us the relationship among CPU, Cache, Main and Secondary memories:

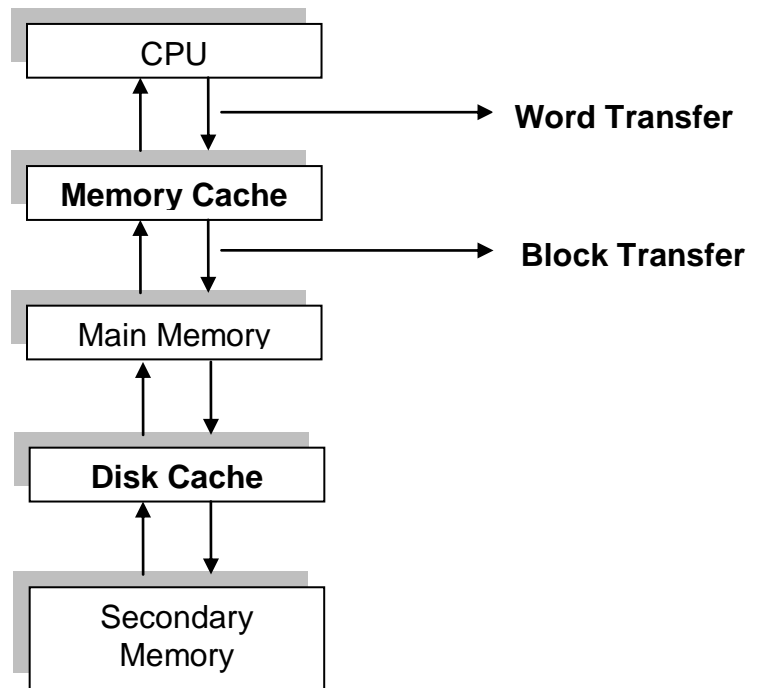

Figure 2.78  
"Relationship among CPU, Cache, Main and Secondary Memories"

### **REGISTERS**

Registers can be defined as:

"Registers are the high speed memory locations built directly into the CPU that are used to hold the data currently being processed"

For example, the control unit might load two numbers from memory into the registers in the ALU. Then it might tell the ALU to divide the two numbers or to see whether the numbers are equal or to perform any other arithmetic operation.

The register in the first PCs could hold two bytes i.e. 16 bits. Most CPU sold today, have 32-bit registers. Many newer PC's as well as minicomputers and high-end workstations, have 16bit registers.

The size of registers, which is sometimes called the “Word Size”, indicates the amount of data with which the computer can work at any given time. The bigger the word size, the more quickly the computer can process a set of data. Occasionally, we hear people refer to “32-bit processors”, or “64-bit processors”, or even “64-bit computer”. This terminology refers to the size of the registers in the processor. If all other factors are kept equal, a CPU with 32-bit registers can process data twice as fast as one with 16-bit registers.

### **CHARACTERISTICS OF REGISTERS**

Following is the brief list of characteristics of Registers:

1. These are used to retain information on a temporary basis.
2. Each register is designed to perform special function.
3. The length of a register equals the number of bits it can store.
4. These are the most expensive and have smallest in size of computer’s memory.
5. Their data accessing speed is fastest in the whole computer system’s memory.
6. These are electronically in nature.
7. The size of registers varies from computer as does the data-flow pattern.
8. The most important effect of registers is to improve raising the processor speed.

### **TYPES OF REGISTERS**

Although the number of registers varies from computer to computer, there are some registers that are common to all computers:

1. Memory Address Registers (MAR)
2. Memory Buffer Register (MBR)
3. Program Control Register (PC)
4. Accumulator Register (A)
5. Instruction Register (I)
6. Input/Output Register (I/O)

### **FUNCTIONS OF REGISTERS**

The main functions and brief detail of each register is given below:

#### **MEMORY ADDRESS REGISTERS (MAR)**

It holds the address of the active memory location. It is loaded from the program control register when an instruction is read from memory.

#### **Memory Buffer Register (MBR)**

It holds the contents of the memory word read from, or written in, memory. An instruction word placed in this register is transferred to the instruction register. A data word placed in this register is accessible for operation with the accumulator register or for transfer to the I/O register. A word to be stored in a memory location must first be transferred to the MBR, from where it is written in memory.

#### **PROGRAM CONTROL REGISTER (PC)**

It holds the address of next instruction to be executed. This register goes through a step-by-step counting sequence and causes the computer to read successive instructions previously stored in memory. It is assumed that instruction words are stored in consecutive memory locations and read and execute in sequence unless a branch instruction is encountered. A *branch instruction* is an operation that calls for a transfer to a non-consecutive instruction. The address part of a branch instruction is transferred to the PC register to become the address of the next instruction. To read an instruction, the contents

of the PC register are transferred to the MAR and a memory read cycle is initiated. The instructions placed in the MBR are then transferred to the instruction register.

**ACCUMULATOR REGISTER (A)**

This register holds the initial data to be operated upon, the intermediate results, and also the final results of processing operations. It is used during the execution of most instructions. The results of arithmetic operations are returned to the accumulator register for transfer to main storage through the memory buffer register. In many computers there are more than one accumulator registers.

**INSTRUCTION REGISTER (I)**

It holds the current instruction that is being executed. As soon as the instruction is stored in this register, the operation part and the address part of the instruction are separated. The address part of the instruction is sent to the MAR while its operation part is sent to the control section where it is decoded and interpreted and ultimately command signals are generated to carry out the task specified by the instruction.

**INPUT/OUTPUT REGISTER (I/O)**

This register is used to communicate with the input/output devices. All input information such as instructions and data is transferred to this register by an input device. Similarly, all output information to be transferred to an output device is found in this register.

Following table summarizes the functions of each of these registers.

Ser. No.	Name of Register	Function
1	Memory Address Register (MAR)	Holds the address of the active memory location
2	Memory Buffer Register (MBR)	Holds the information on its way to and from memory
3	Program Control Register (PC)	Hold the address of the next instruction to be executed
4	Accumulator Register (A)	Accumulates results and data to be operated upon
5	Instruction Register (I)	Holds an instruction while it is being executed
6	Input/output Register (I/O)	Communicates with the input and output devices

Table 2.6  
“Basic Functions of different types of registers”

## 2.9 DIFFERENCE BETWEEN PRIMARY MEMORY AND SECONDARY MEMORY

SER. NO.	DIFFERENCES	PRIMARY MEMORY	SECONDARY MEMORY
1	<b>Storage Period</b>	Temporarily as well as permanent	Permanent
2	<b>Price</b>	Costly	Cheaper
3	<b>Speed</b>	Faster	Slower
4	<b>Size</b>	Less in size	More in size
5	<b>Size Measuring</b>	Its size normally measure in kilo or in mega bytes	Its size normally measure in mega and giga bytes

SER. NO.	DIFFERENCES	PRIMARY MEMORY	SECONDARY MEMORY
6	<b>Nature</b>	Electronic	Magnetic, Electromagnetic or optical
7	<b>Relation with Processor</b>	Closely connected to processor	Not closely connected to processor
8	<b>Active data</b>	Holds the data or programme that is actively using by processor	Do not holds the data or programme that is actively using by processor
9	<b>Interaction with Processor</b>	Interacts with processor millions of times per second.	Do not interacts with processor millions of times per second.
10	<b>File</b>	Data is not organized into files	Data is organized into files
11	<b>Other Names</b>	Main memory, Volatile memory, Temporary memory	Auxiliary memory, Non volatile or Electromagnetic memory, Permanent memory
12	<b>Types</b>	RAM, ROM	Magnetic, Optical

## 2.10 DIFFERENCE BETWEEN RAM AND ROM

SER. NO.	DIFFERENCES	RAM	ROM
1	<b>Main Function</b>	Help in execution of program and instructions	Help in booting
2	<b>Link with Processor</b>	Direct link	Indirect link
3	<b>Nature of Data Stored</b>	Temporary	Permanent
4	<b>Nature</b>	Volatile	Nonvolatile (actually it is also volatile)
5	<b>Data or Instructions</b>	Continuously changeable data and instructions	Continuously not changeable data and instructions
6	<b>Instruction Writing</b>	Instructions are written into it at the time of execution	Instructions are written into it normally at the time of manufacturing
7	<b>Who Can Read, Write or Delete Data</b>	Computer user	Computer manufacturers and users as well.
8	<b>Full Name</b>	RAM	ROM-BIOS
9	<b>Other Name</b>	User's memory	System's memory
10	<b>Reading and Writing Ability</b>	From beginning it is read and writeable	Now it is also read and writeable
11	<b>Installation</b>	Easily installation on motherboard	Not easy installation on motherboard
12	<b>Special Skills</b>	No special skills required to write data on it	Special skills required to write data on it
13	<b>Special</b>	No special equipments	Special equipments required

SER. NO.	DIFFERENCES	RAM	ROM
	<b>Equipments</b>	required to write data on it	to write data on it
14	<b>Price</b>	Cheaper	Expensive
15	<b>Size</b>	More	Less
16	<b>Technology</b>	CMOS	Semiconductor
17	<b>Types</b>	DRAM, SRAM	PROM, EPROM, EEPROM

## **2.11 DIFFERENCE BETWEEN SRAM AND DRAM**

Ser. No.	Differences	SRAM	DROM
1	<b>Main Purpose</b>	Decrease the processing time	Decrease the processing cost
2	<b>Refresh Rate</b>	Many times in a second	Hundreds of times in a second
3	<b>Speed</b>	Fast	Slow
4	<b>Popularity</b>	Not so popular	Popular
5	<b>Price</b>	Expensive	Cheaper
6	<b>Power Consumption</b>	More power consumption	Less power consumption
7	<b>Availability</b>	Not easily available	Easily available
8	<b>Access time</b>	25-35 nanoseconds	80-120 nanoseconds
9	<b>Size</b>	Less	More
10	<b>Types</b>	No type	SIMM, DIMM

# **EXERCISE**

## **LONG QUESTIONS**

1. Draw and briefly explain the basic components of a computer system?
2. What do you know about the architecture of computer? Explain.
3. What is hardware? Explain the types of computer hardware in detail?
4. What is device? Explain the input devices in detail?
5. What is output? Write a note on softcopy output devices?
6. Write a note on hardcopy output devices?
7. What do you know about the devices which are input as well as output devices?
8. Differentiate between:
  - i. Impact and nonimpact printers
  - ii. Dotmatrix and LASER printers
9. Explain microprocessor in detail?
10. What is memory? Explain its types in detail?
11. Explain Special memories used in computer system?
12. Explain the following difference in detail:
  - i. Primary and Secondary memories
  - ii. RAM and ROM
  - iii. SRAM and DRAM
13. What is port? Write a note on different types of ports?



## **SHORT QUESTIONS**

**1. What are the two basic parts of a computer system?**

Hardware and software are the two basic parts of a computer system.

**2. What is hardware?**

The physical and permanent components of a computer are called hardware. For example monitor, keyboard, printer, mouse etc

**3. Enlist the basic types of hardware?**

- i. CPU
- ii. Memory
- iii. Input/output devices

**4. What is software?**

A set of electronic instructions consisting of complex codes, or programs, that makes up the computer are called the software. For example MS-Windows 2000 Professional, MS-Word 2000, Jet Audio etc.

**5. Enlist the basic types of software?**

- i. System software
- ii. Application software

**6. What is the functional study of computer?**

Functional study of computer means the study of computer software.

**7. What is data processing cycle?**

The user inputs the data through input unit; the data goes for processing, meanwhile or after processing results stored in memory temporarily/permanent and then the output of results (information) goes to output unit.

**8. What are the basic units of computer?**

Input unit, Processing unit and Output units are the basic units of computer.

**9. Enlist the basic parts of Processor?**

- i. Arithmetic and logic unit
- ii. Memory unit
- iii. Control unit

**10. Write down the functions of any input device?**

- i. It accepts (or reads) the list of instructions and data from the outside world of computer.
- ii. It converts these instructions and data in computer acceptable form.
- iii. It supplies the converted instructions and data to the computer system for further processing.

**11. Where CPU resides?**

CPU resides on motherboard.

## **12. What are the functions of CPU?**

- i. Fetch, means get an instruction or data from Main Memory
- ii. Decode, translate it into computer commands
- iii. Execute, means actually process the command
- iv. Store, means write the results in main memory

## **13. Enlist the basic functions of memory unit?**

- i. Having all the data to be processed and the instructions required for processing (received from input devices).
- ii. Having intermediate results of processing.
- iii. Having final results of processing before these results are released to an output device.

## **14. What is Address?**

Each storage location in memory is distinguished by a unique number called its address.

## **15. Enlist the functions of ALU?**

- i. This is the calculating section of the computer. It performs arithmetic processing like addition, subtraction, multiplication, division exponention.
- ii. The other function of ALU is to allow the computer system to make decision during the execution of program, called the logical operation or decision like less than, greater than, equal to, not equal to etc.
- iii. Remember that some of the logical operations/decision making can be done on the text data.
- iv. It can also compare alphabetic information, such as names or determine whether one name is same as or different from another.

## **16. Enlist the basic functions of CU?**

- i. It is like a traffic policeman controlling the movements of vehicles on the road. Control unit controls the flow of data inside the computer system. It is the “nervous system” of the machine. It coordinates and controls the computer system just as the brain directs the body. It does not execute the instructions itself but instead directs other parts of the computer system to do so.
- ii. It controls all the units/devices or parts of computer system directly or indirectly. It obtain instructions from the internal memory unit. After interpreting, the control unit transmits directions to the appropriate components of the computer. Ordering them to perform the required operations.
- iii. Directly control to ALU and MU.
- iv. Indirectly control to input and output units.
- v. The control unit tell the input device and secondary storage device what data and instructions to read into memory, tell the ALU where the data to be processed, what operations to perform on data, where in memory the results are to be stored and finally, it directs the appropriate output devices to convert processed data into human readable form. After an instruction is executed the control unit proceeds to the next instruction.
- vi. How i/o devices knows that its time to get data from computer or enter data to system this is done by cu.
- vii. Only final results of an execution is send to out put devices

viii. It manages the order of execution.

**17. What is output unit?**

Unit which is used to get data from the computer to user is called the output unit.

**18. Write down the functions of any output device?**

- i. It accepts the results produced by the computer which are in coded form and hence cannot be easily understood by us.
- ii. It converts these coded results to human acceptable (readable) form,
- iii. It supplies the converted results to the outside world.

**19. What is motherboard?**

All the physical components of computer reside on a circuit board called the motherboard (or mainboard).

**20. What are the peripheral devices?**

The input devices and the output devices provide the means of communication between the computer and the outer world. These are also known as *Peripheral Devices* because these surround the computer.

**21. What is input?**

It is a process to enter something.

**22. How can you define the word Device?**

Device is purely based on electronics circuits.

**23. Define input devices?**

A device which is used to accept data from the user, translate it into computer understandable form and sends to internal parts for further processing.

**24. Write down the types of input devices?**

- i. Standard input devices
- ii. Nonstandard input devices

**25. Give examples of standard input devices?**

- i. Keyboard
- ii. Mouse

**26. Give examples of nonstandard input devices?**

- i. Scanner
- ii. Light pen
- iii. Joy stick etc

**27. Write down the types of output devices?**

- i. Standard output devices
- ii. Nonstandard output devices

Or

- i. Softcopy output device
- ii. Hardcopy output devices

**28. Give examples of standard output devices?**

- i. Monitor
- ii. Printer

**29. Give examples of nonstandard output devices?**

- i. Plotter
- ii. Speaker
- iii. PC-Projector etc

**30. What is softcopy?**

The untouchable copy is called softcopy. For example output from monitor or speaker is the softcopy.

**31. What is hardcopy?**

The touchable copy is called hardcopy. For example output from printer or plotter is the hardcopy.

**32. Give examples of softcopy output devices?**

- i. Monitor
- ii. Speaker
- iii. PC-Projector

**33. Give examples of hardcopy output devices?**

- i. Printer
- ii. Plotter

**34. Which coding system is associated with the keyboard?**

American Standard Code for Information Interchange (ASCII) is associated with the keyboards.

**35. How many keys are present in IBM Enhanced Keyboard layout?**

101 keys are present in IBM Enhanced Keyboard layout.

**36. How many types of keyboards do we have? Name them?**

We have two types of keyboard:

- i. General purpose keyboards
- ii. Special purpose keyboards

**37. In how many groups are the keys of IBM Enhanced Keyboard divided? Name them?**

There are 6-groups:

- i. Alphanumeric keys
- ii. Modifier keys
- iii. Numeric keypad
- iv. Function keys
- v. Cursor-movement keys
- vi. Special-purpose keys

**38. Where the functional keys arise? Briefly explain their purpose?**

The keys are usually arranged in a row along the top of the keyboard, these are twelve in number from F1 to F12. Each Function key's purpose depends on the program we are using. For example, F1 is the help key.

**39. What is mouse?**

A Mouse is a point and draw type of standard input device that rolls around on a flat surface and controls the pointer.

**40. What are the functions/operations performed by a mouse?**

Following are the functions of a mouse:

- i. Pointing
- ii. Clicking
- iii. Double-clicking
- iv. Dragging
- v. Dragging and Dropping
- vi. Right-clicking

**41. What is scanner?**

Scanners allow information such as a photo or text to be input into a computer i.e. it is used to convert hardcopy into softcopy.

**42. What is output?**

It is a process to get something.

**43. Define output devices?**

A device which is used to get processed data called information, translate it into user understandable form, and gives output.

**44. What are the other names of monitor?**

Other name of monitors are: Display Unit, Screen, Display Screen, Video Display Terminal (VDT), Video Display Unit (VDU), Screens, Cathode Ray Tube (CRT), Liquid Crystal Display (LCD).

**45. What is XGA?**

It stands for Extended Video Graphic Array, which offers up to 16.7 million colors.

**46. Define Printer?**

It is a hardcopy, standard output device, which is used to give the color or black and white printing of any type of data.

**47. How many types of printers we have?**

We have two types of printers:

- i. Impact printers
- ii. Non impact printers

**48. What is DPI?**

It stands for "dots per inch". More the DPI rate of printer or scanner, clearer will be the image i.e. real image.

**49. Which factors are to be taken while buying a printer?**

We need to look following factors while buying a Printer:

- i. Speed or output
- ii. Quality of output
- iii. Size
- iv. Multiple carbon copies
- v. Expense of ink or toner
- vi. Initial cost
- vii. Operational cost

**50. Name some of the devices which can be used as input as well as output devices?**

- i. Processing devices
- ii. All the memory devices like:
- iii. Network devices like:
- iv. Terminal
- v. Touch Screen Monitors
- vi. Audio cards
- vii. Video cards
- viii. Digital cameras etc

**51. What is Bus?**

The bus is a group of wires on the main circuit board of the computer. It is a pathway for data flowing between components.

**52. What is microprocessor?**

The computer's brain which organizes and carries out instructions from either the user or the software. It is also simply known as processor or central processing unit (CPU).

**53. What is hertz?**

Number of machine cycles completed per second.

**54. What are the speed limits and front bus speeds of P-I, P-II, P-III and P-IV computers?**

Microprocessor's Speed		
Model Name	Speed Limit	Front Bus
Pentium-I	100MHz to 233MHz	66MHz
Pentium-II	233MHz to 450MHz	100MHz
Pentium-III	450MHz to 1.3GHz	133MHz
Pentium-IV	1.4GHz to Onwards	400MHz to 800MHz

**55. What is the speed of light?**

Speed of electron is the speed of light that is 1,86,000 miles per second.

**56. Define memory?**

Memory is the electronic or magnetic holding place for instructions and data that our computer's microprocessor can reach quickly.

**57. What do you know about memory/storage units?**

These are the units to measure the computer's memory. Following is their detail:

Unit Name	Unit Symbol	Unit Size
Bit	b	-
Nibble	N	4-Bits
Byte	B	8-Bits
Kilo Byte	KB	1024-Byte
Mega Byte	MB	1024-Kilo Byte
Giga Byte	GB	1024-Mega Byte
Tera Byte	TB	1024-Giga Byte
Peta Byte	PB	1024-Tera Byte
Exa Byte	EB	1024-Peta Byte
Zetta Byte	ZB	1024-Exa Byte
Yotta Byte	YB	1024-Zetta Byte

**58. How many types of memory we have? Name them?**

We have two types of memory. Their names are:

- i. Primary memory or Primary storage devices
- ii. Secondary memory or Secondary storage devices

**59. What is primary memory?**

It is also known as the *main memory* of computer. The data stored in this type of memory is of temporary nature and stays in memory until processing. As this memory is costly so its size is limited than the secondary memory.

**60. What are the other names or primary memory?**

Its other names are Main memory, Volatile memory, Temporary memory etc.

**61. What are the types of primary memory?**

- i. Random Access Memory (RAM)
- ii. Read Only Memory (ROM)

**62. What are the types of RAM?**

- i. Dynamic Random Access Memory (DRAM)
- ii. Static Random Access Memory (SRAM)

**63. What are the types of ROM?**

- i. Programmable Read Only Memory (PROM)
- ii. Erasable Programmable Read Only Memory (EPROM)
- iii. Electrically Erasable Programmable Read Only Memory (EEPROM)

**64. What is secondary memory?**

It is also known as the *auxiliary memory* or *auxiliary storage* or *permanent memory* of computer. The data stored in this type of memory is of permanent nature and stays in memory permanently. As this memory is cheap so its size is more than the primary memory. Devices which are used to store secondary memory are called the “*secondary storage devices*”.

**65. What are the other names of secondary memory?**

Its other names are Auxiliary memory, Non volatile or Electromagnetic memory, Permanent memory etc.

**66. What are the types/examples of secondary memory?**

- i. Magnetic Storage Media:
  - a. Magnetic Tape Storage
  - b. Magnetic Disks Storage:
    - 1. Hard Disks
    - 2. Floppy Disks
- ii. Optical Storage Media:
  - c. CR-ROM
  - d. Rewriteable Optical Disk
  - e. DVD-ROM
  - f. WORM Disk
  - g. Zip Disks etc.

**67. What is track?**

Each magnetic disk consists of a number of invisible circles called Tracks.

**68. What is Cylinder?**

A set of corresponding tracks in the entire surface is called Cylinder.

**69. What is Sector?**

Tracks on a disk are split up into Sectors.

**70. How to check performance of a hard disk?**

- i. The data rate - the number of bytes per second that the drive can deliver to the CPU. Rates between 5 and 40 megabytes per second are common.
- ii. The seek time - the amount of time it takes between the time that the CPU requests a file and the first byte of the file starts being sent to the CPU. Times between 10 and 20 milliseconds are common.

**71. What are the sizes, densities and capacities of floppy disks?**

Size	Density	Capacity
5.25"	Double	360KB
5.25"	High	1.2MB
3.5"	Double	720MB
3.5"	High	1.44MB

**72. What is CD-ROM?**

CD-ROM stands for "compact disk-read only memory". It is new technology of storage media as compare to floppy disks. These are made up of flexible material such as plastic etc. their storage capacity is from 680MB to 1GB. These can be written once and can be read so many times, but its contents can not be changed. But now we also have rewritable CDs.

**73. What is DVD-ROM?**

DVD-ROM stand for "Digital Versatile Disk Read Only Memory". It is a new development that has dramatically increased the storage capacity of data. It offers high quality of audio and video. It can store up to 2GB of data. It uses short wave length of LASER to read and write data on it. It has two tracks each for audio and video, it makes



full use of each track to give high quality of audio and video. It was first used in Holly Wood Film Industry.

**74. What is WORM?**

It stands for "Write Once Read Many". It is a disk like CD-ROM, but it can store grater amount of data. It is used in workstations and super computers. This can store up to 200GB of data. Famous libraries uses it to store digitized versions of books. It has life more than 30 years.

**75. What is the sequence of different memories in memory hierarchy?**

- i. Registers
- ii. Cache
- iii. Main memory
- iv. Disk cache
- v. Magnetic disk
- vi. Removable media

**76. Name the two important types of special memories?**

- i. Registers Memory
- ii. Cache Memory

**77. What are the types of cache memory?**

- i. Memory caching
- ii. Disk caching

**78. What are the types of memory cache?**

- i. Internal Cache
- ii. External Cache

**79. Define registers?**

Registers are the high speed memory locations built directly into the CPU that are used to hold the data currently being processed.

**80. Name some important types of registers?**

- i. Memory Address Registers (MAR)
- ii. Memory Buffer Register (MBR)
- iii. Program Control Register (PC)
- iv. Accumulator Register (A)
- v. Instruction Register (I)
- vi. Input/Output Register (I/O)